

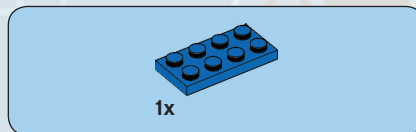

9485

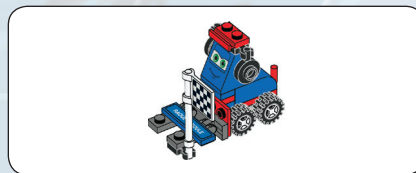

WARNING: CHOKING HAZARD.
Toy contains small parts and a small ball.
Not for children under 3 years.

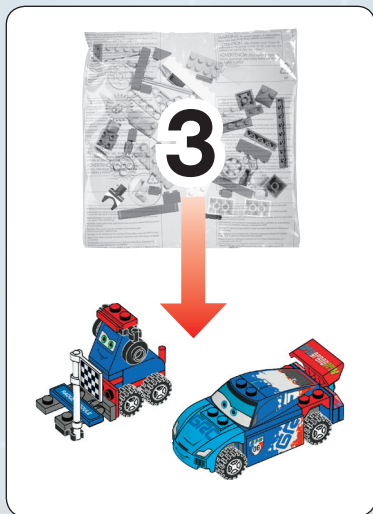

1

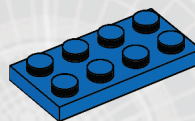

AVERTISSEMENT : RISQUE D'ÉTOUFFEMENT.

Le jouet contient des petites pièces ainsi qu'une petite boule.
Il ne convient pas aux enfants de moins de 3 ans.



ADVERTENCIA: PELIGRO DE ASFIXIA.

Juguete que contiene partes pequeñas y una pelota pequeña.
No recomendado para niños menores de 3 años.



2x

2



1x



1x

3

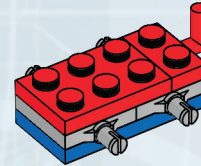

3

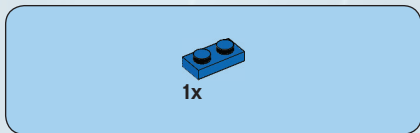

4

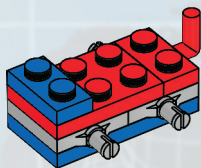

4

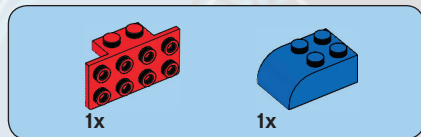

5

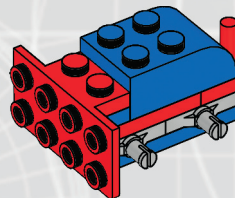

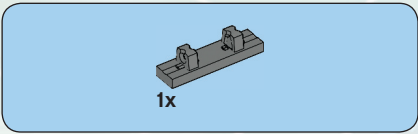

6

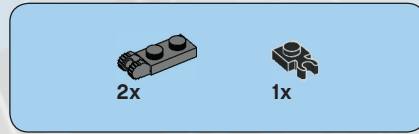
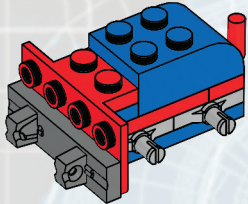

7

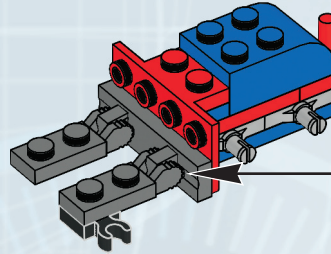
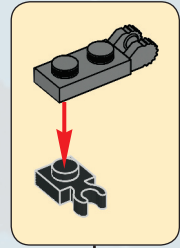

5

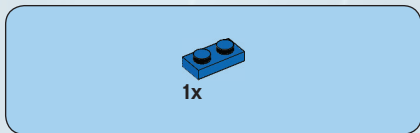

8

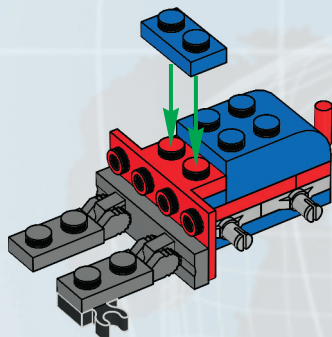

6



9

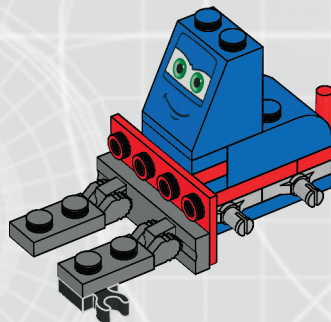



2x

10

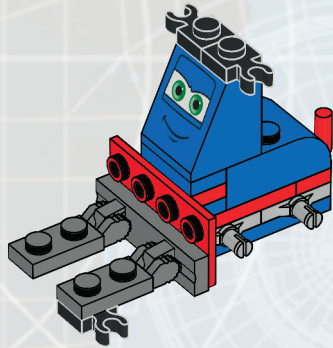

2x



1x

11

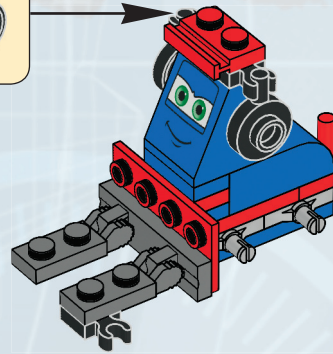

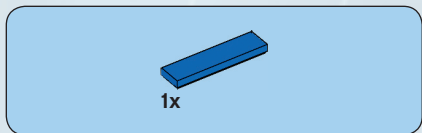

12

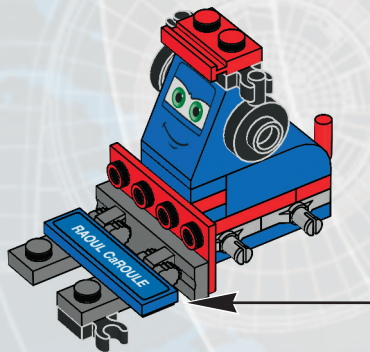
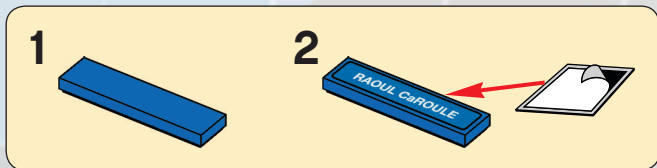

8

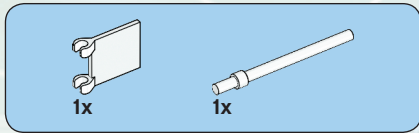

13

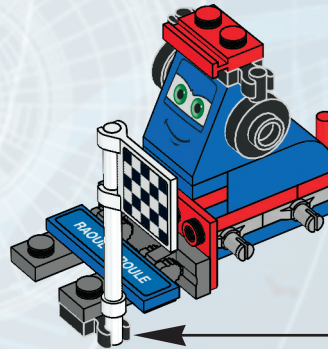
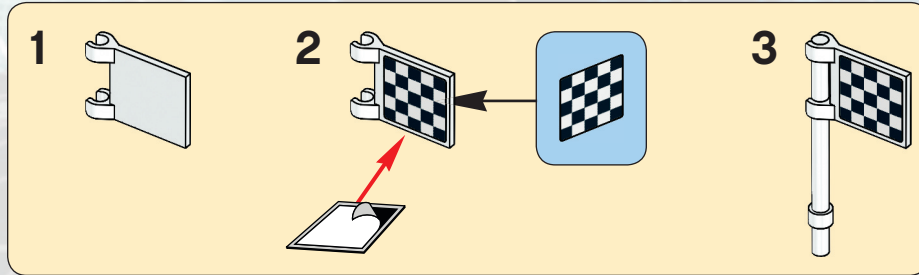



4x



4x

14

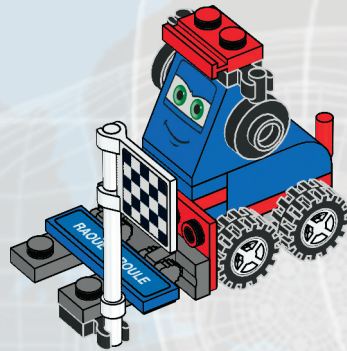

10

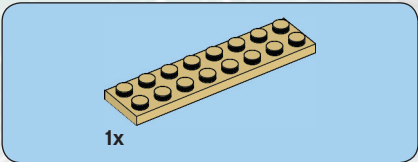
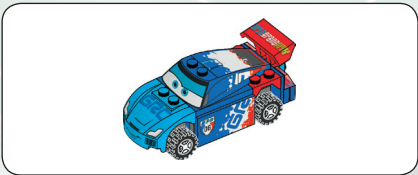

1x

1

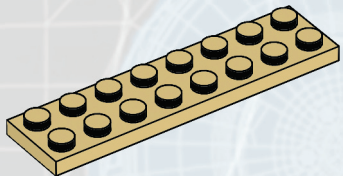

2x

2

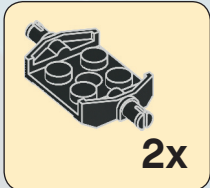

2x

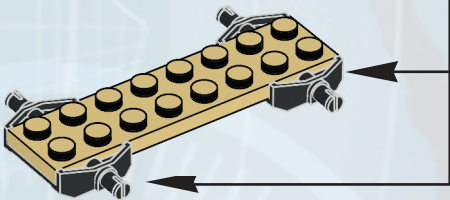

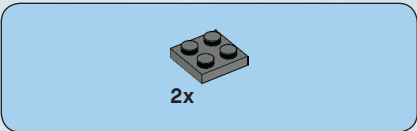

3

waypoint

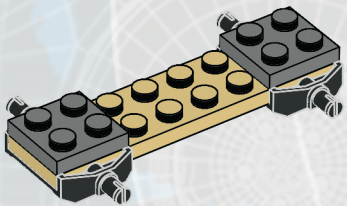



4

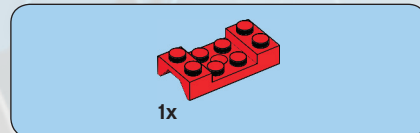
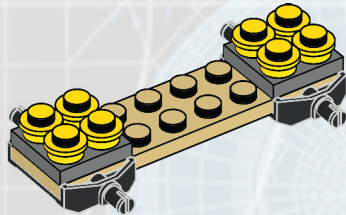

5

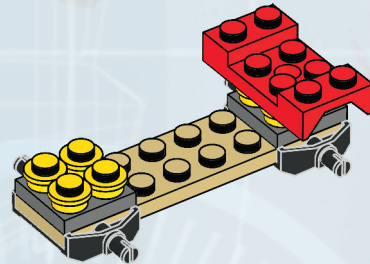

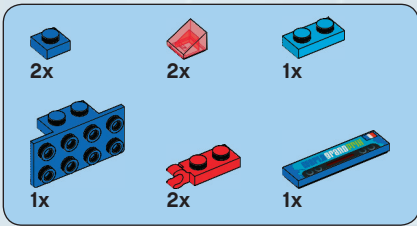

6

1

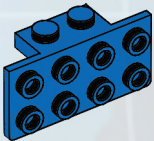

2

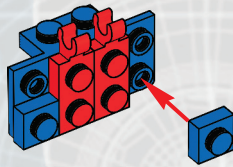

3

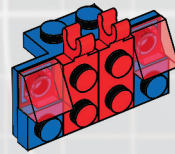

waypoint 2

target acquired

4

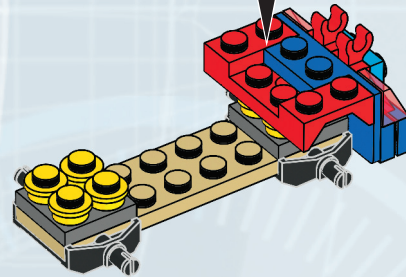
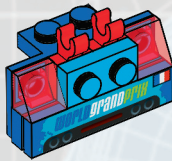

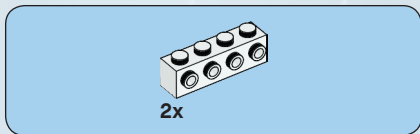

7

waypoint

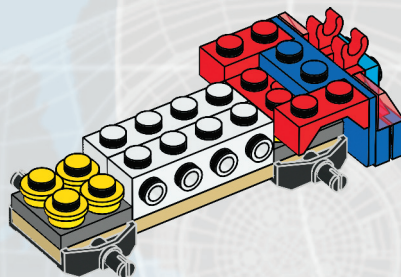

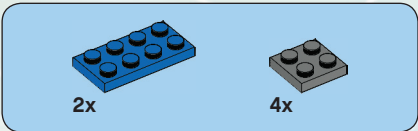

8

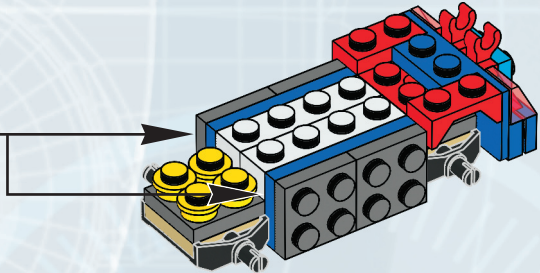
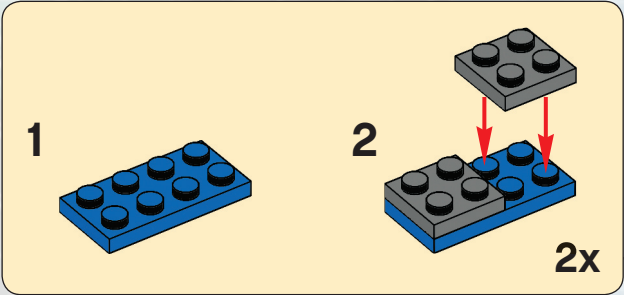

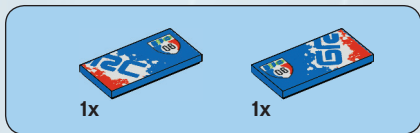

9

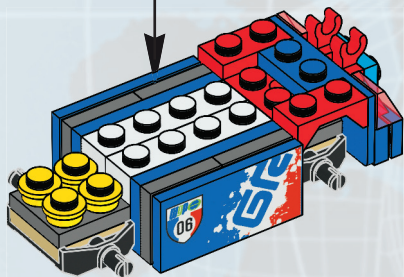

10

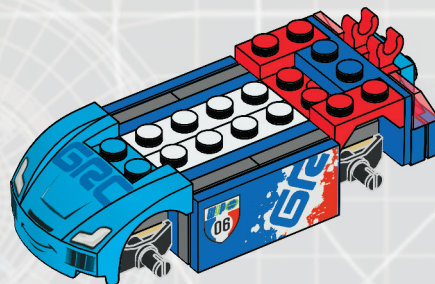

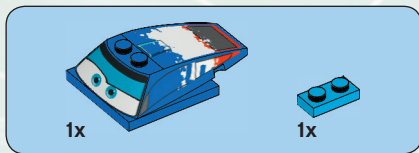

11

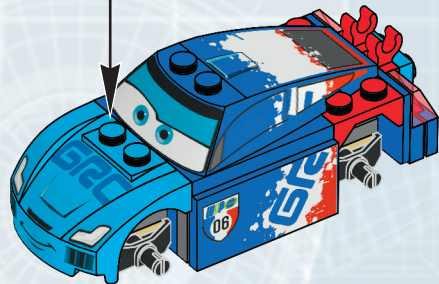
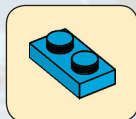

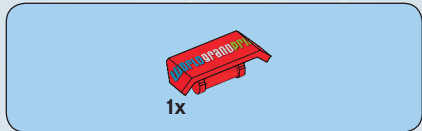

12

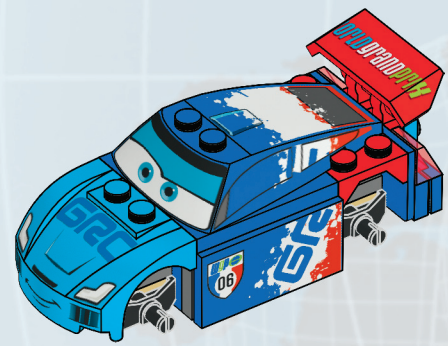

13

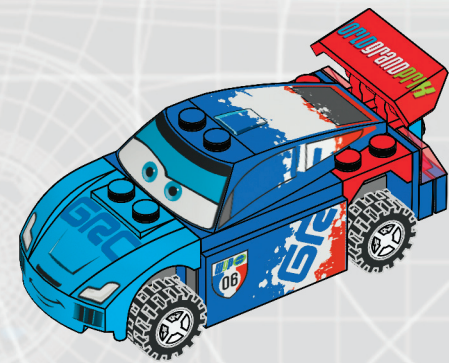

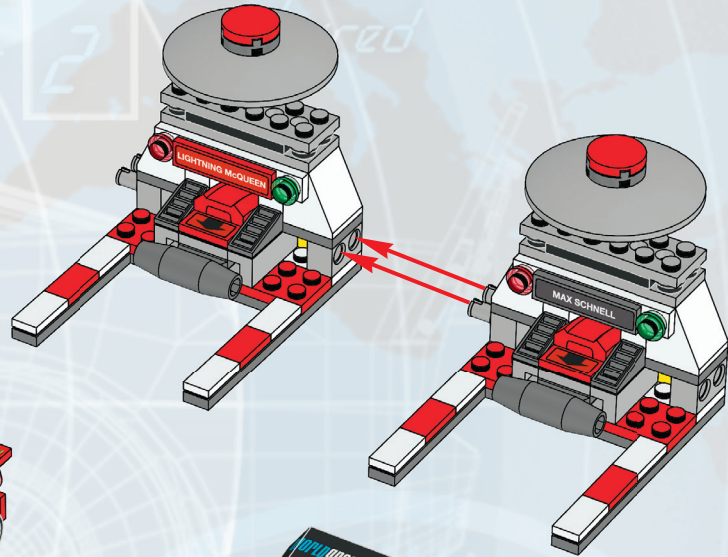
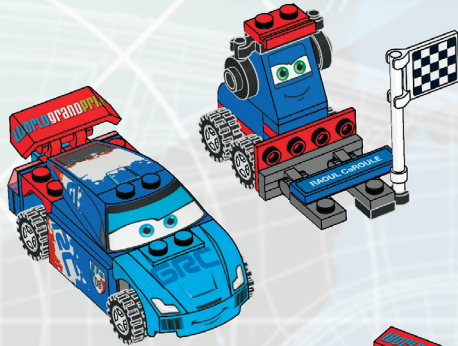

4x
300501

4x
4234525

2x
4534648

1x
4616800

1x
4600176

1x
4653729

1x
4653635

4x
300401

2x
4143254

1x
302321

3x
4282742

4x
4653566

1x
4653709

1x
4648084

4x
302101

1x
4523403

4x
242021

1x
4653563

1x
4653582

1x
621523

1x
243123

2x
366601

1x
4538720

6x
302121

1x
243121

1x
4613132

2x
302423

8x
614124

8x
306901

3x
4113988

2x
415021

1x
4623286

2x
4144413

7x
302323

4x
4239601

8x
462401

1x
4623276

6x
306921

1x
4623278

1x
4654233

3x
302023

4x
4262786

2x
4282737

1x
4611701

1x
4623280

2x
4544143

1x
4653633

2x
371024

22

1x
4612575

1x
4612575

2x
4290714

1x
4653634

4x
379424

2x
4611704

3x
4550017

6x
615726

4x
4558953

2x
4535738



1x
4653628

4x
4257526

1x
4622569

2x
4632571

1x
4653624

2x
4211660

4x
4211451

6x
4211094

2x
4210884

1x
4211053

4x
4107761

2x
370626

4x
4211613

4x
4652459

4x
4211043

1x
4653600

4x
4211042

2x
370926

2x
379528

2x
4211541

2x
4211504

4x
4211001

1x
4648067

2x
4660877

14x
614126

2x
4244363

4x
4211395

1x
4653720

2x
4211115

1x
4653607

6x
4540386

2x
452826

2x
4201019

4x
4211542

2x
4653988

1x
4653612

8x
4578677

4x
3005741

2x
4211796

2x
4210635

8x
4246901

2x
3005748

1x
4653210



Customer Service

Kundenservice

Service Consommateurs

Servicio Al Consumidor

www.lego.com/service or dial



: 00800 5346 5555

: 1-800-422-5346



Go to www.LEGOsurvey.com/product
to fill out a survey for a chance
to win a cool LEGO® Product.

No purchase necessary.

Open to all residents where not prohibited.

www.LEGOsurvey.com/product

GEWINNE!

Nimm an der Umfrage auf
www.LEGOsurvey.com/product
teil und hab die Chance ein cooles
LEGO® Produkt zu gewinnen!
Die Teilnahme am Gewinnspiel führt zu keinerlei
Kaufverpflichtungen. Teilnahme in allen nicht
ausgeschlossenen Ländern möglich.

WIN!

Ga naar www.LEGOsurvey.com/product,
vul een enquêteformulier
in en maak kans op een
cool LEGO® product.
Geen aankoopverplichting.
Iedereen mag deelnemen, uitgezonderd
ingezetenden van landen waar een
enquêteverbod geldt.

GAGNE !

Visite www.LEGOsurvey.com/product
pour répondre à un
questionnaire et avoir une
chance de gagner un produit
LEGO® très cool !
Aucune obligation d'achat.
Ouvert à tous les résidents des pays
autorisés.

当てよう!

www.LEGOsurvey.com/product
にアクセスして、
アンケートにご記入ください。
当選者にはレゴ®製品を
差し上げます。
お買い上げの必要はありません。
禁止されていない限り、すべての皆様にご利用いただけます。



www.LEGO.com

6003672

LEGO and the LEGO logo are trademarks of the/sont des marques de commerce de/
son marcas registradas de LEGO Group. ©2012 The LEGO Group. © Disney/Pixar