



# DINO



5887



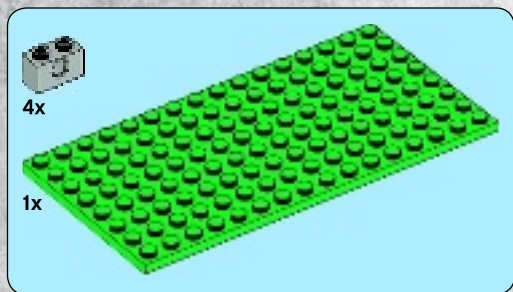
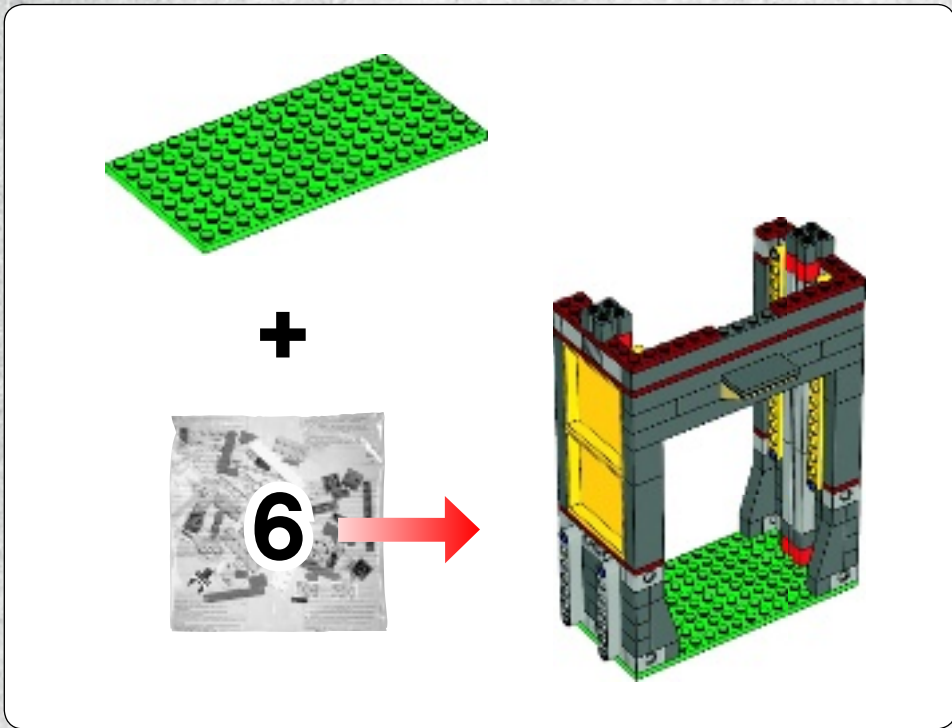
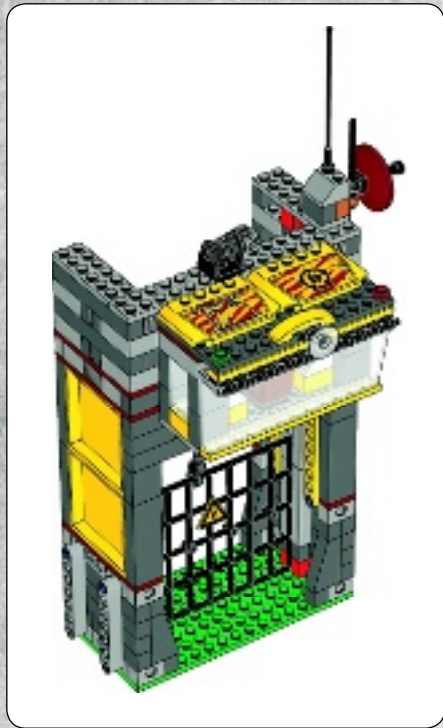

1

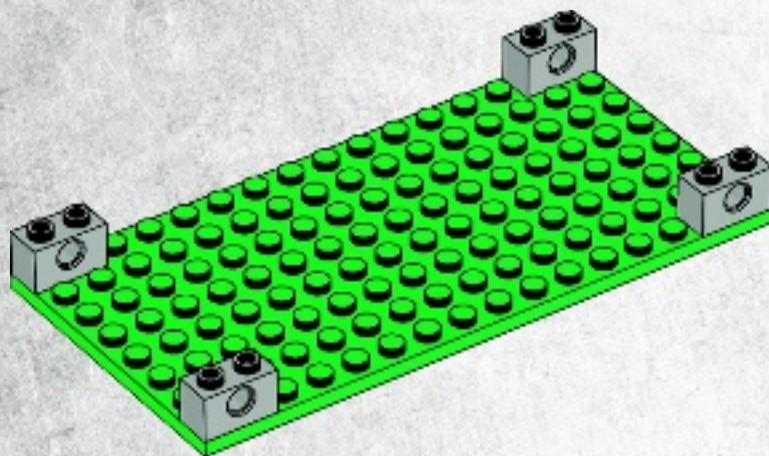



4x

2

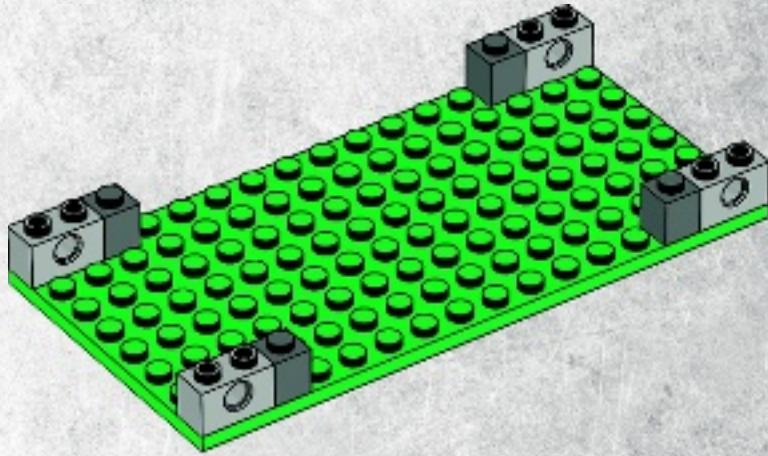

4x



2x

3

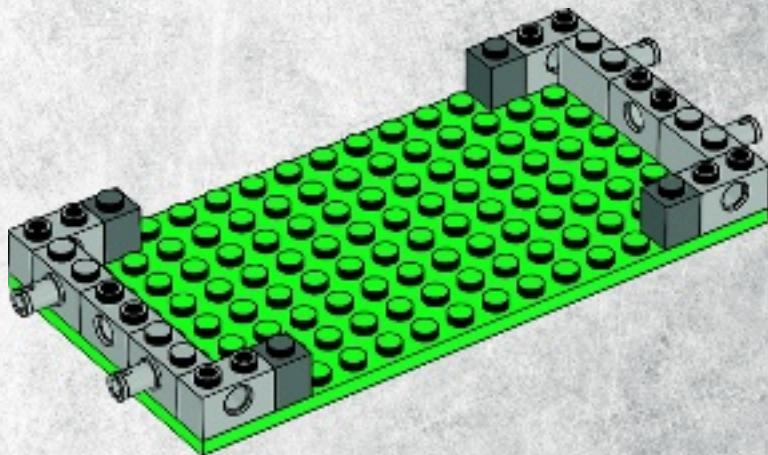



2x

4

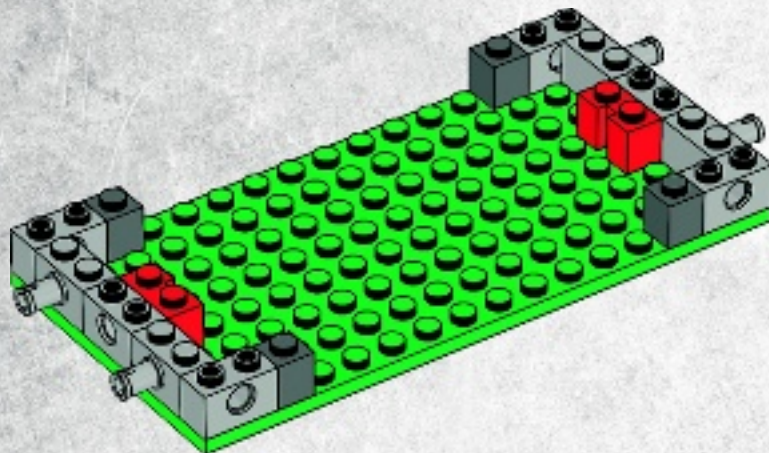

2x

5

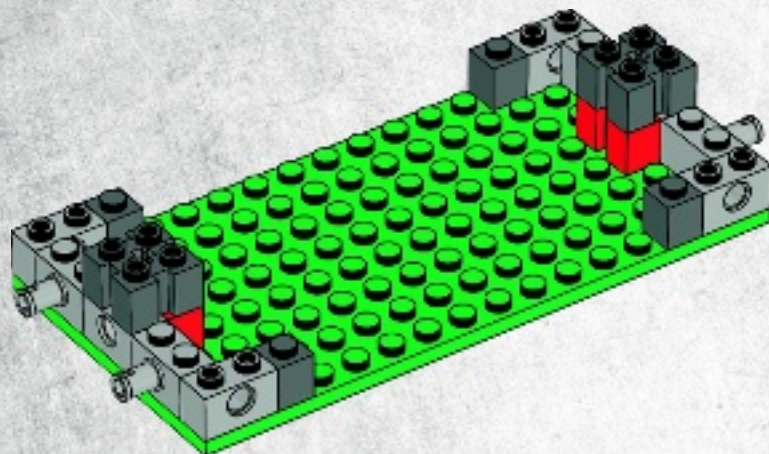



6

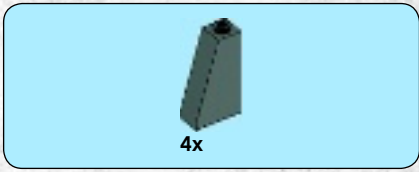
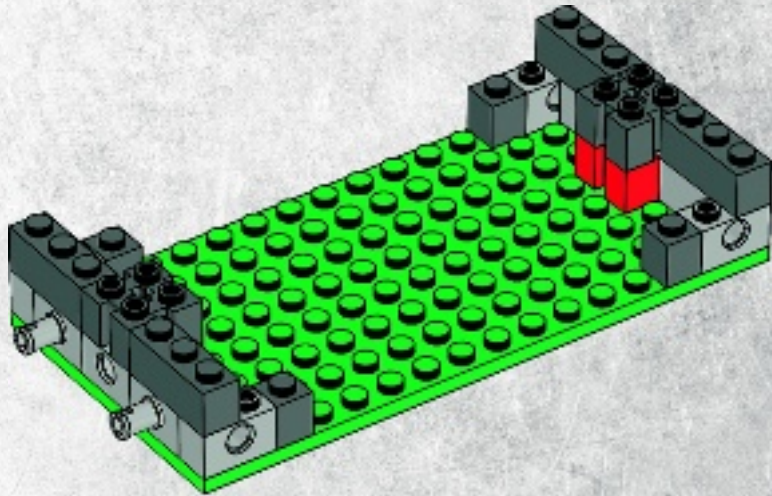

7

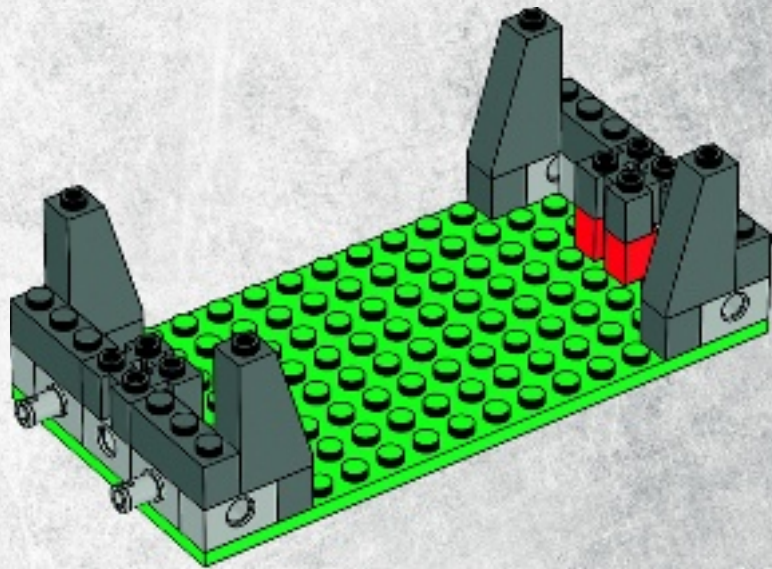

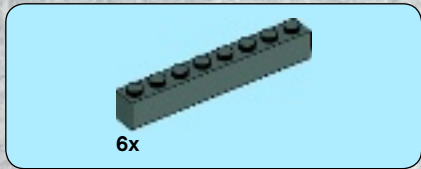

8

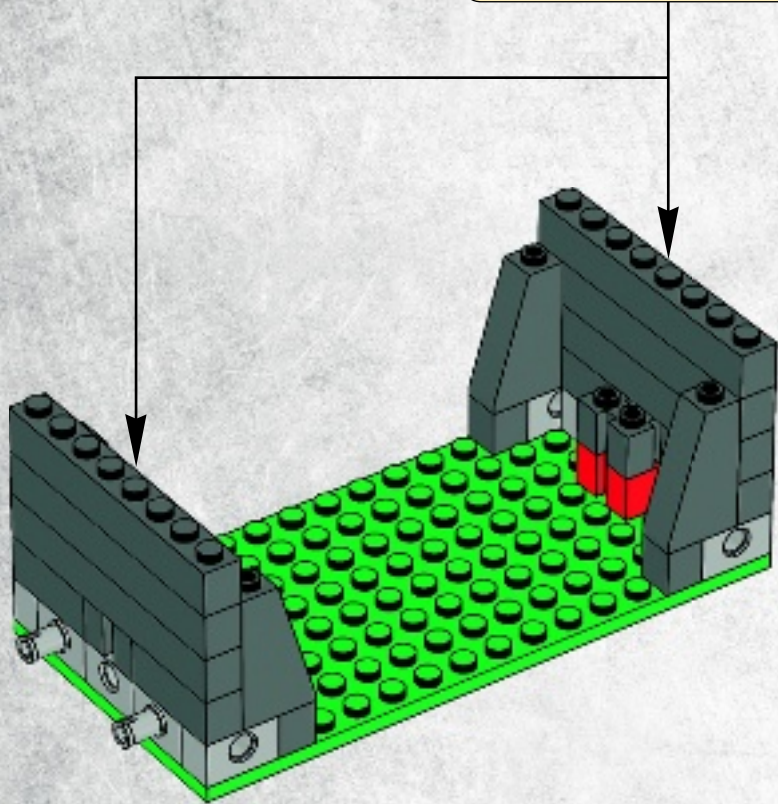
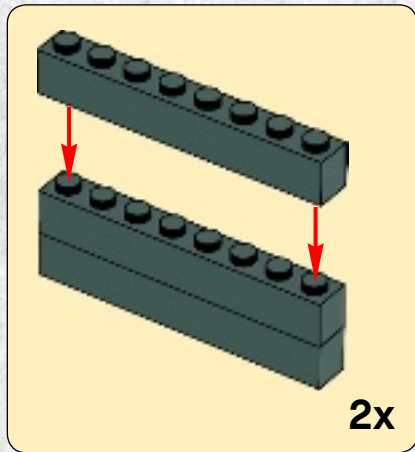



4x

9

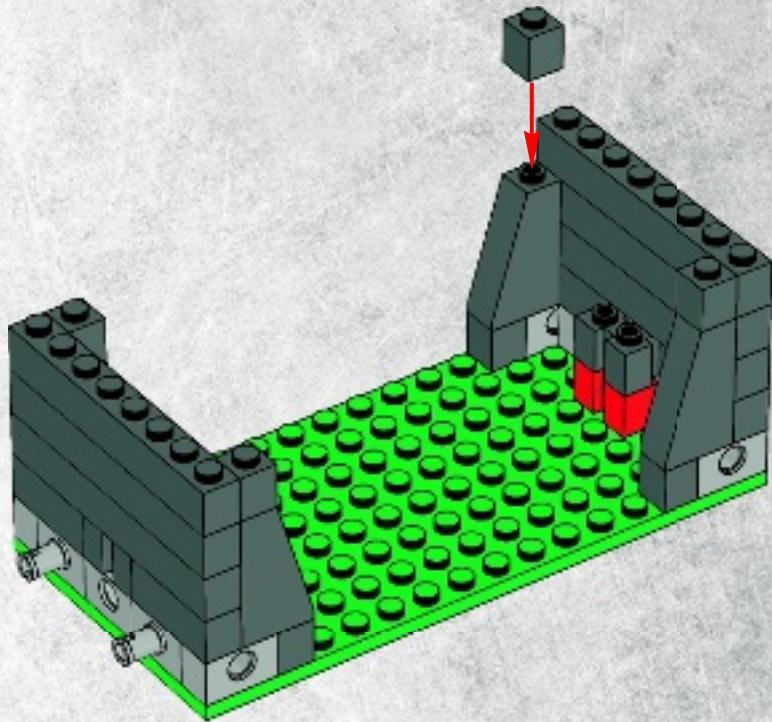



4x

# 10

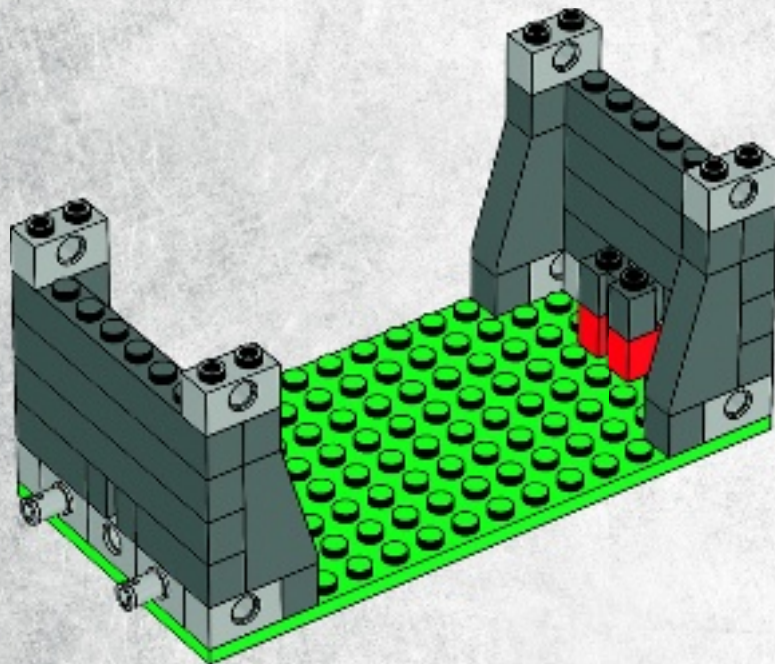





2x

# 11

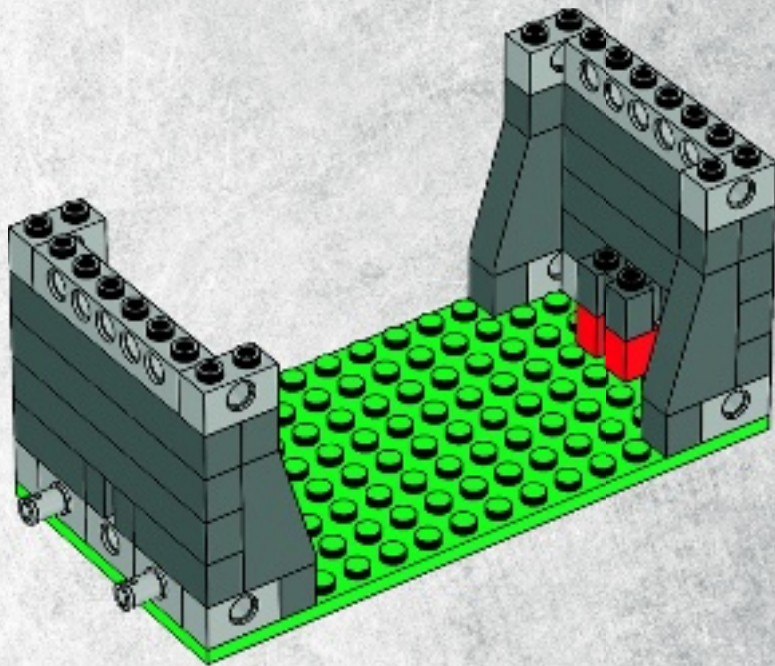



# 12

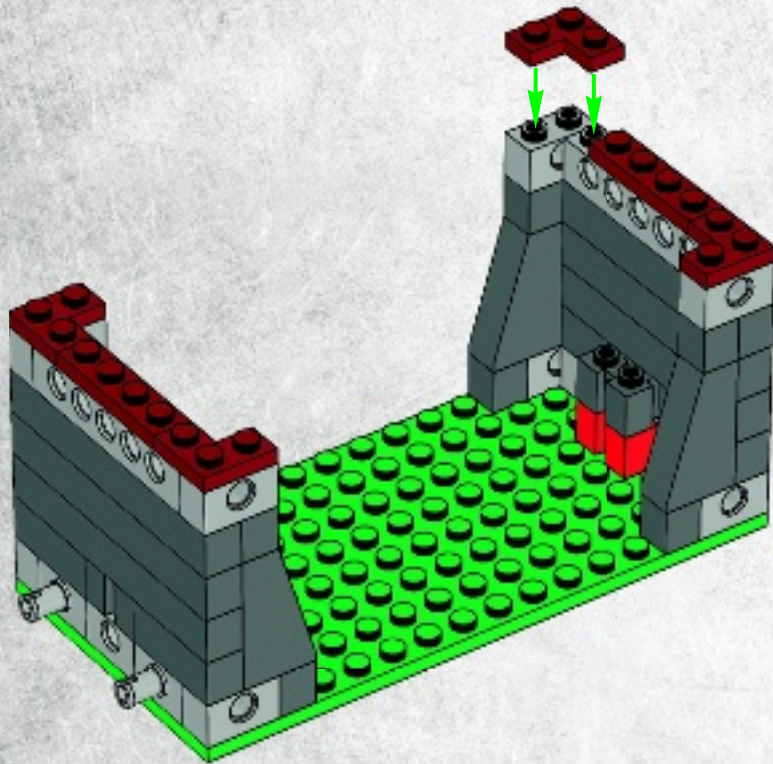

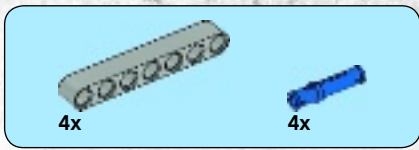

# 13

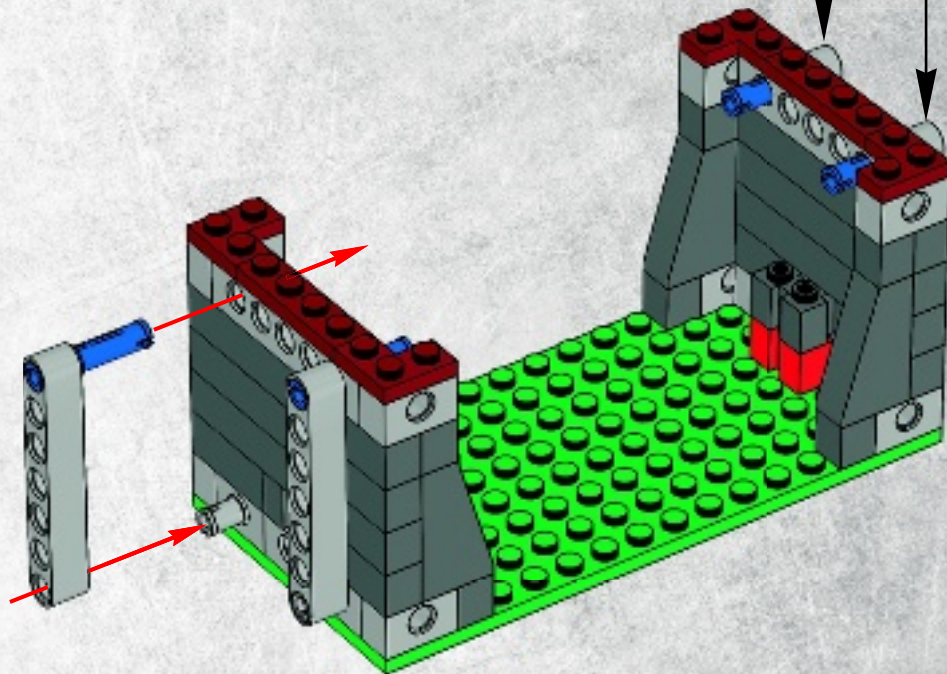
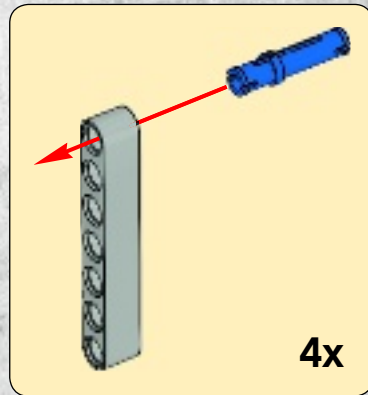

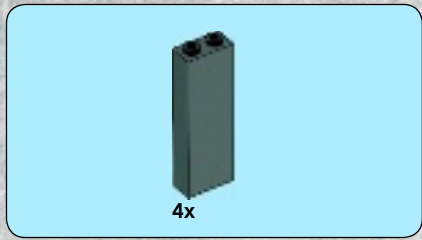

14

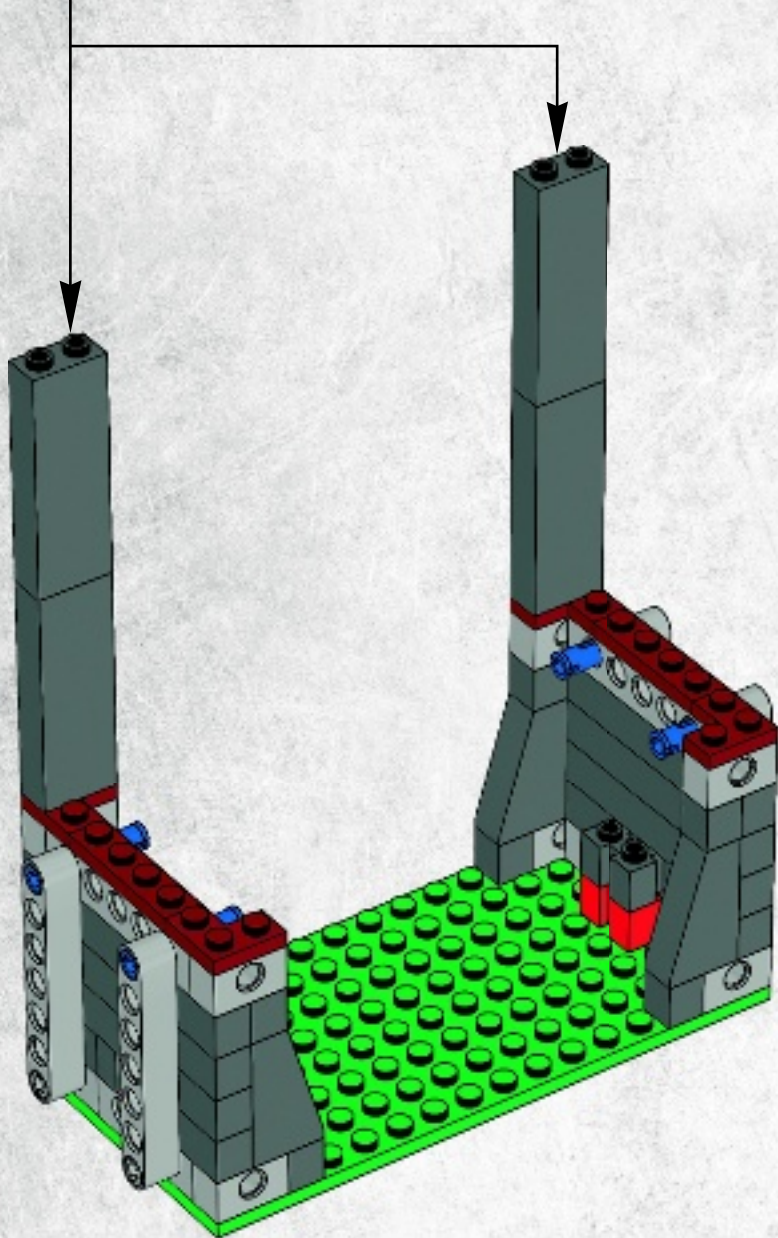
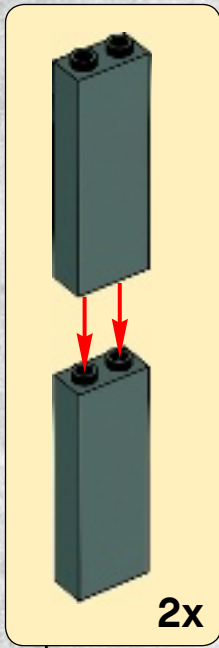

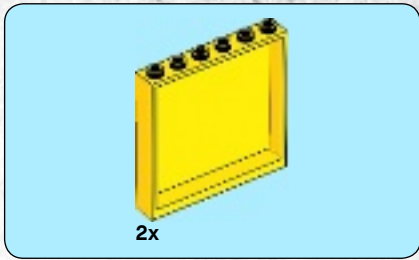

15

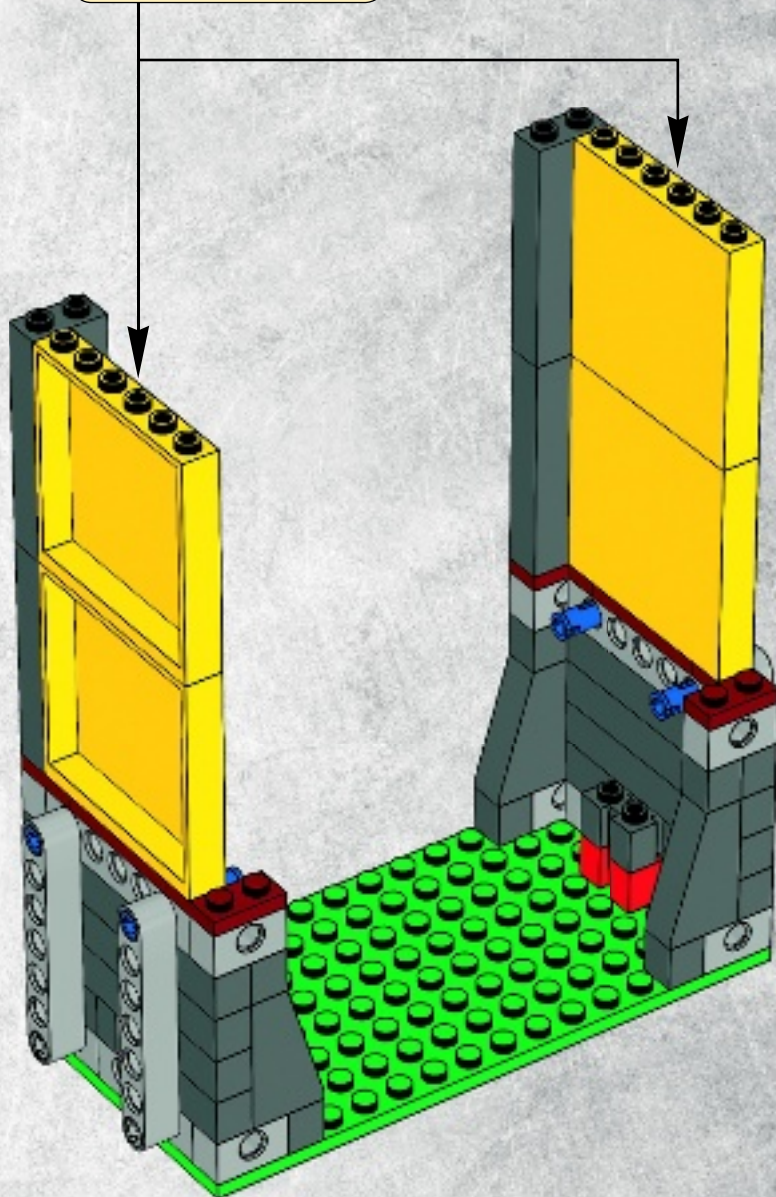
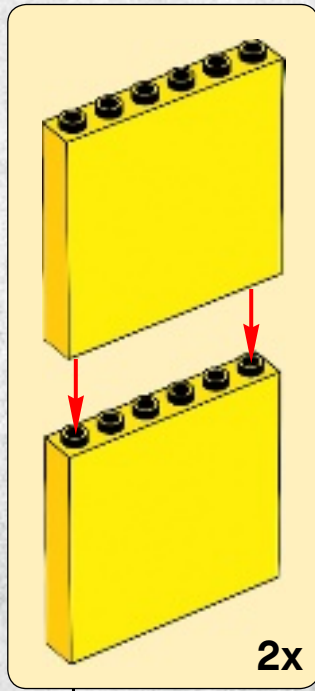



# 16

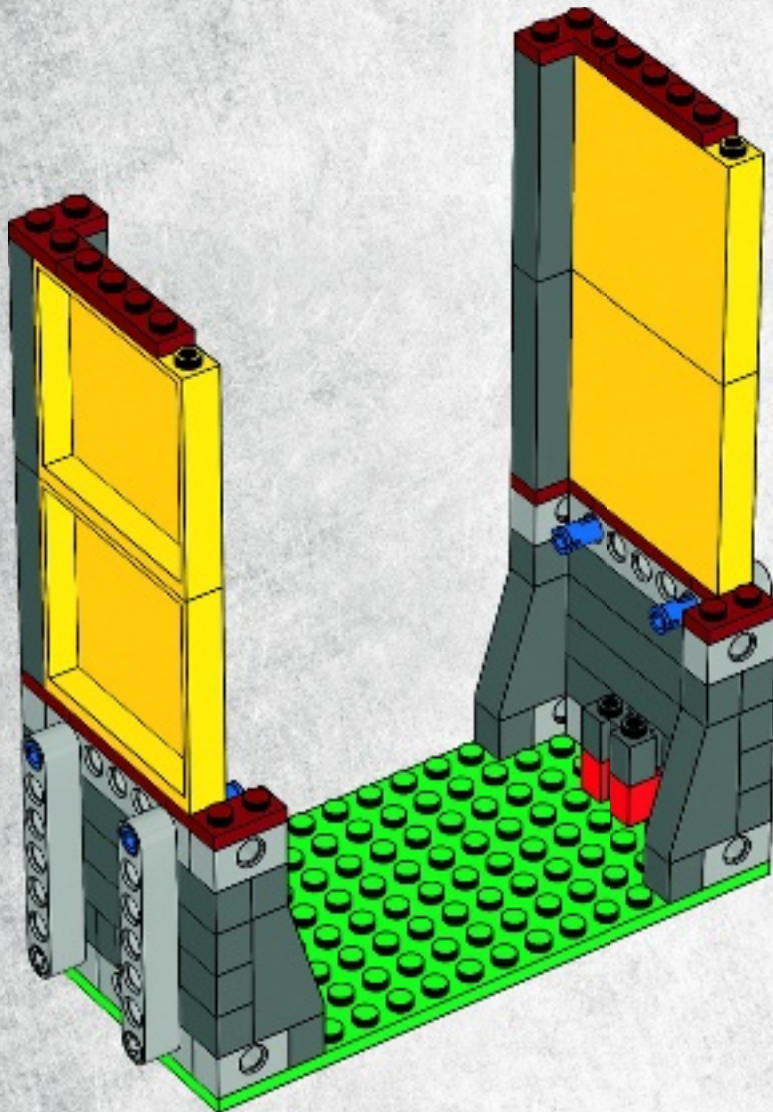

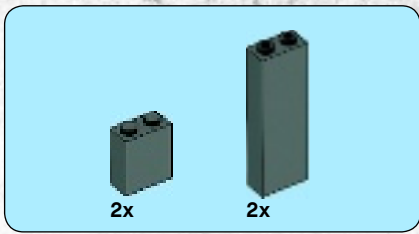

17

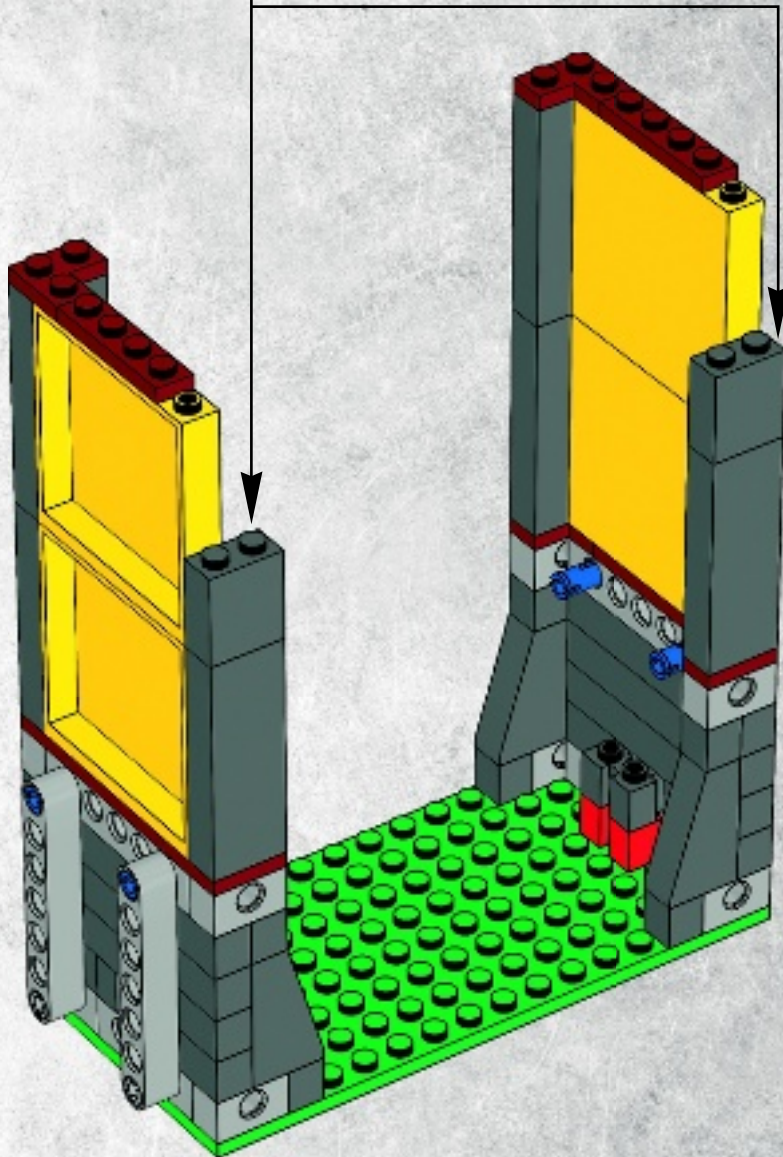
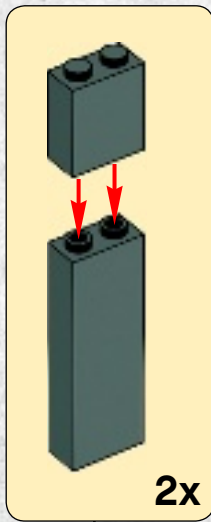

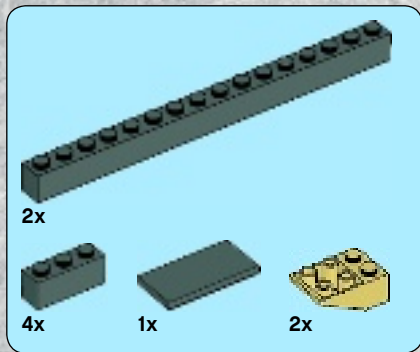

18

1

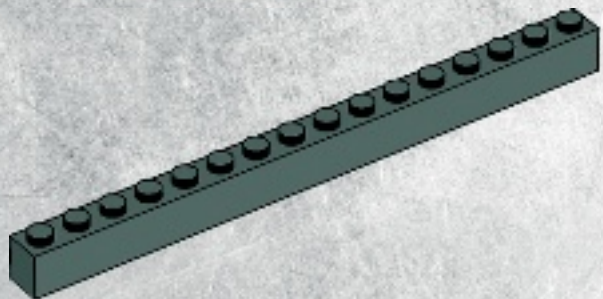

2

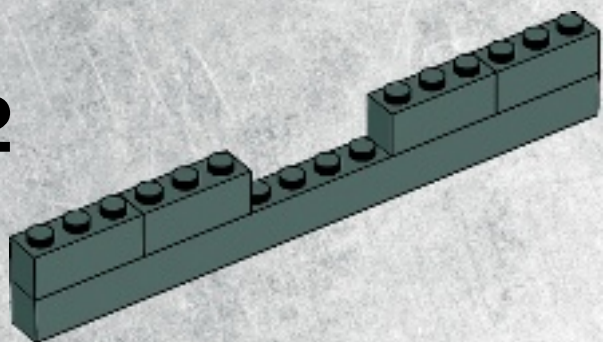

3

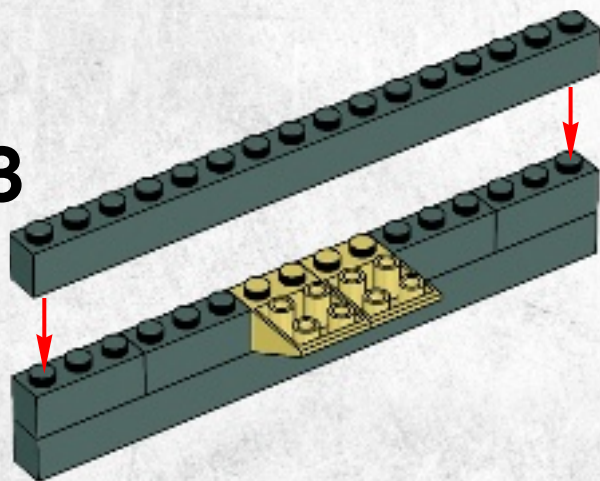

4

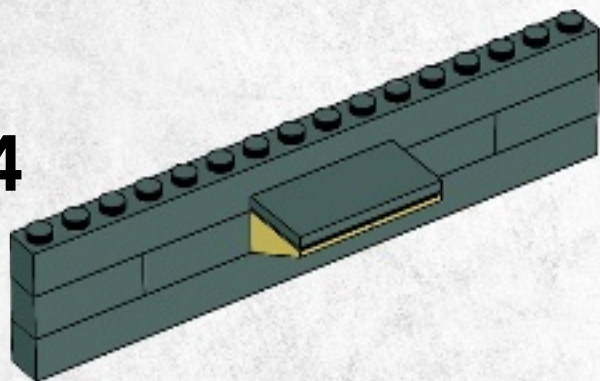



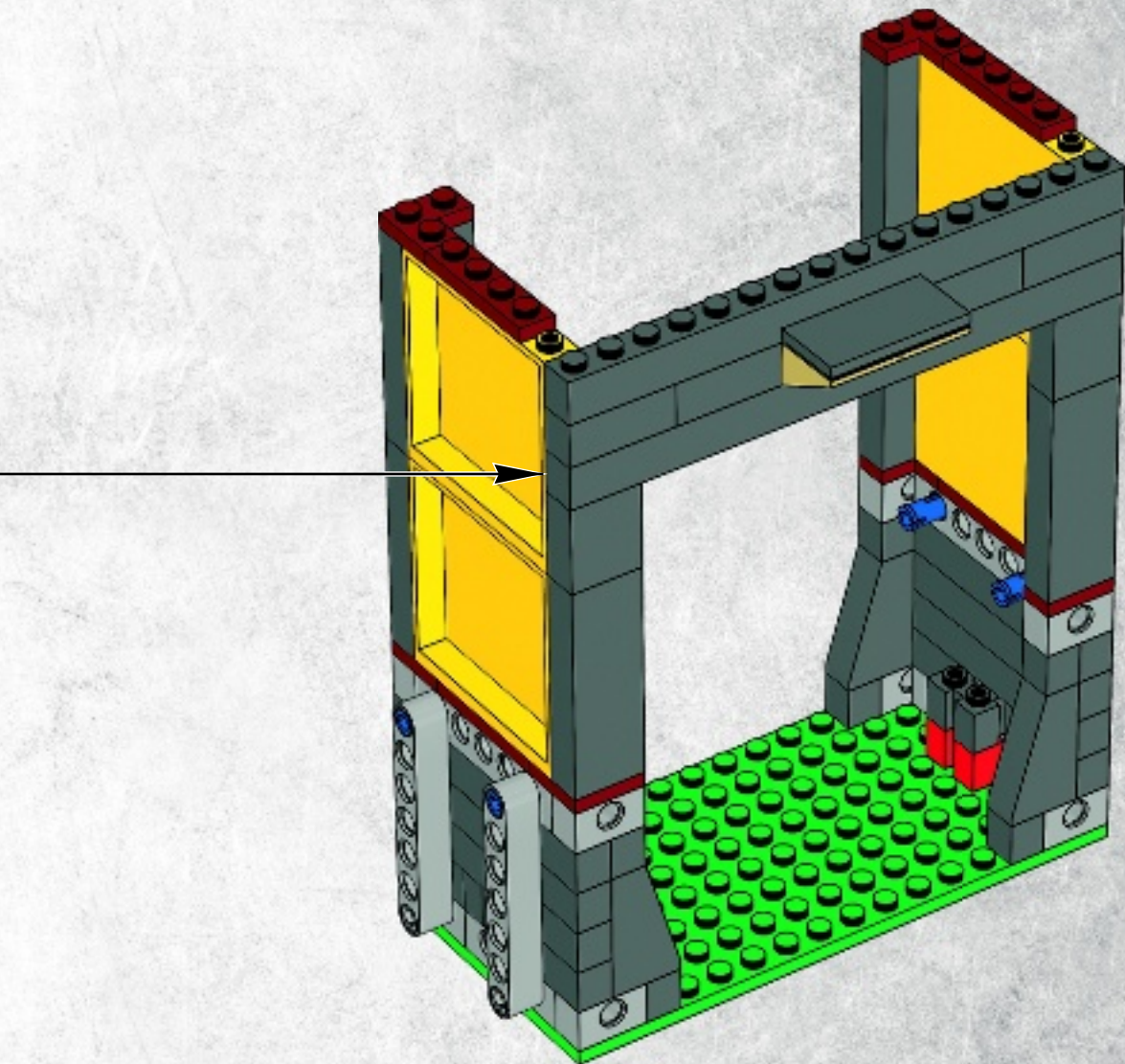



2x



3x

# 19

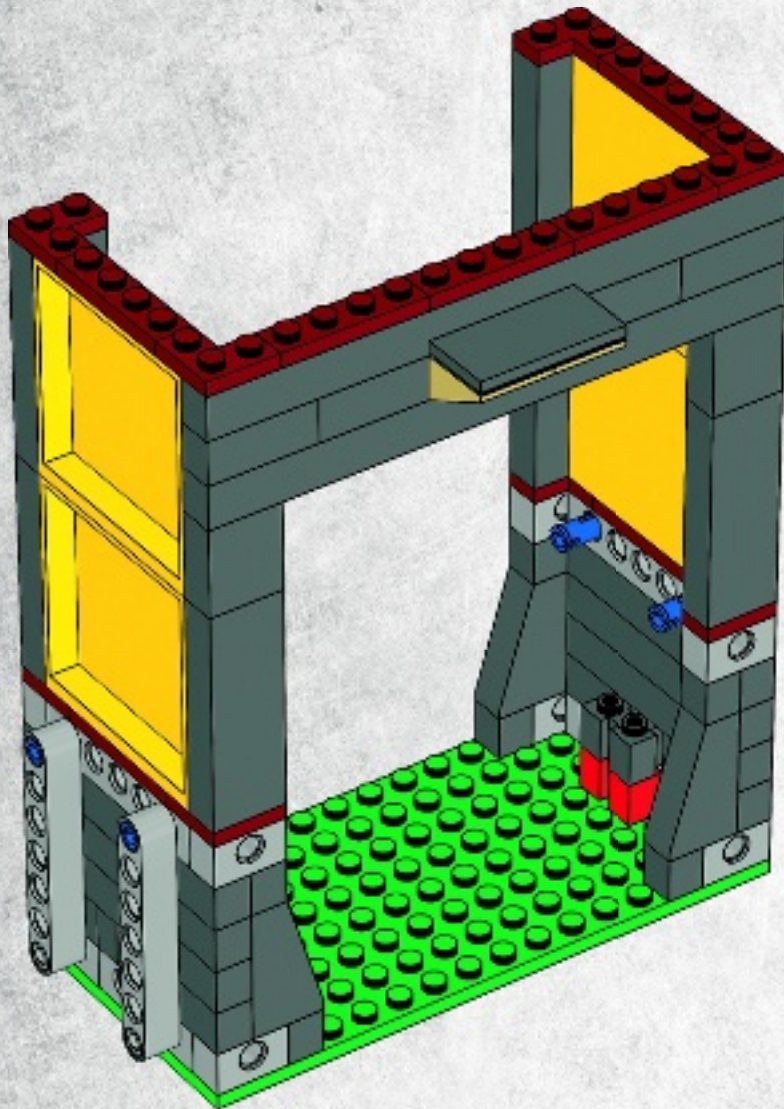



4x



4x

# 20

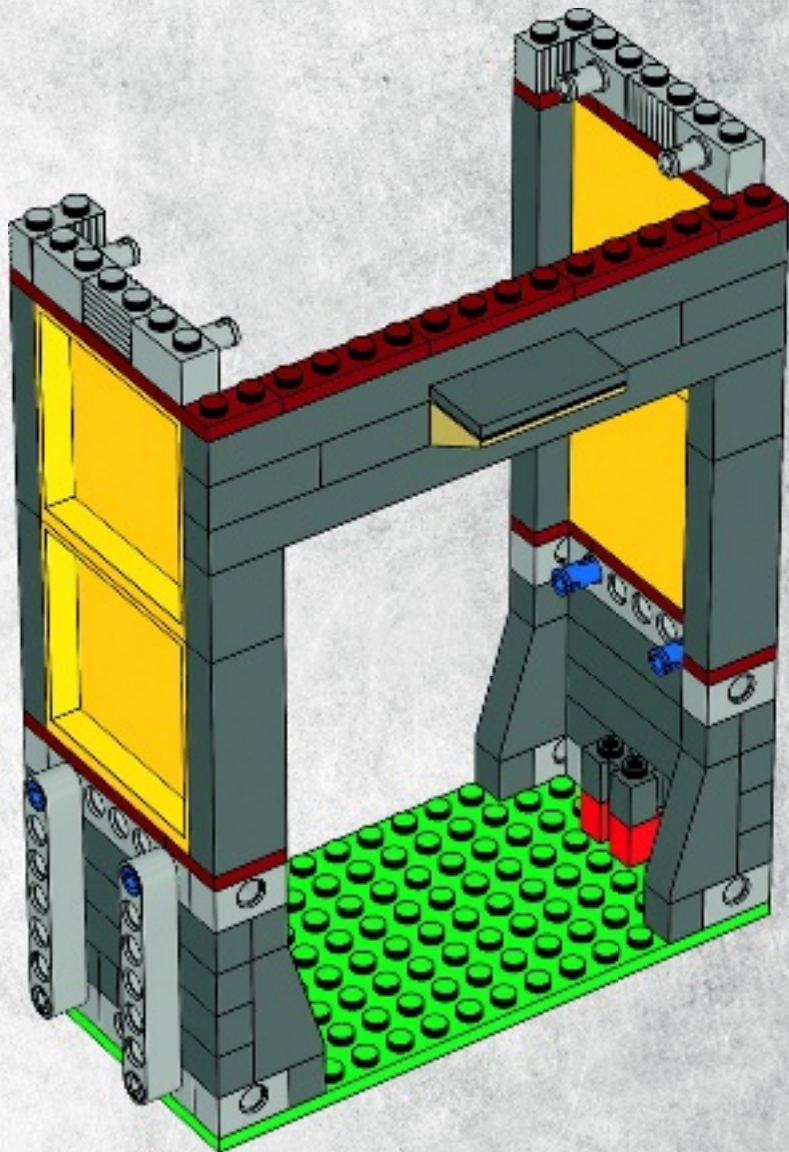

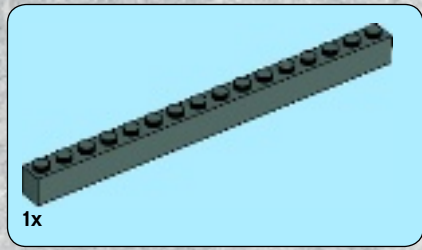

21

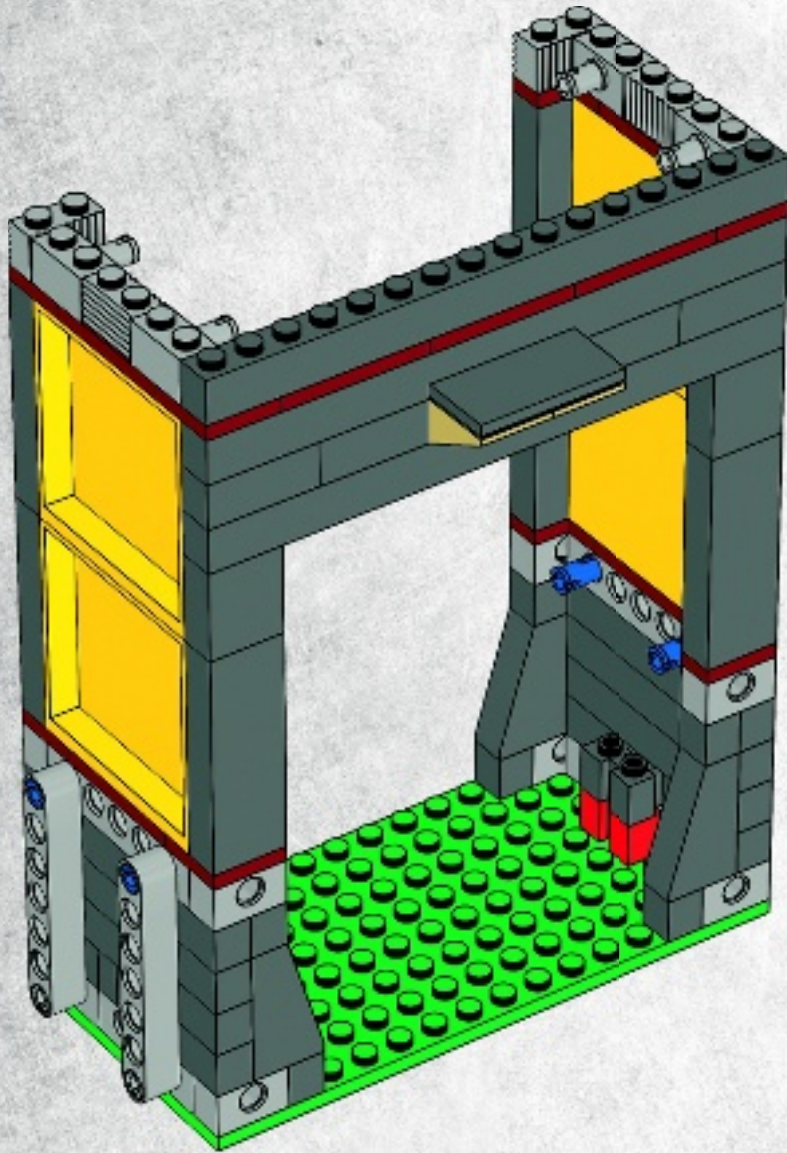



22

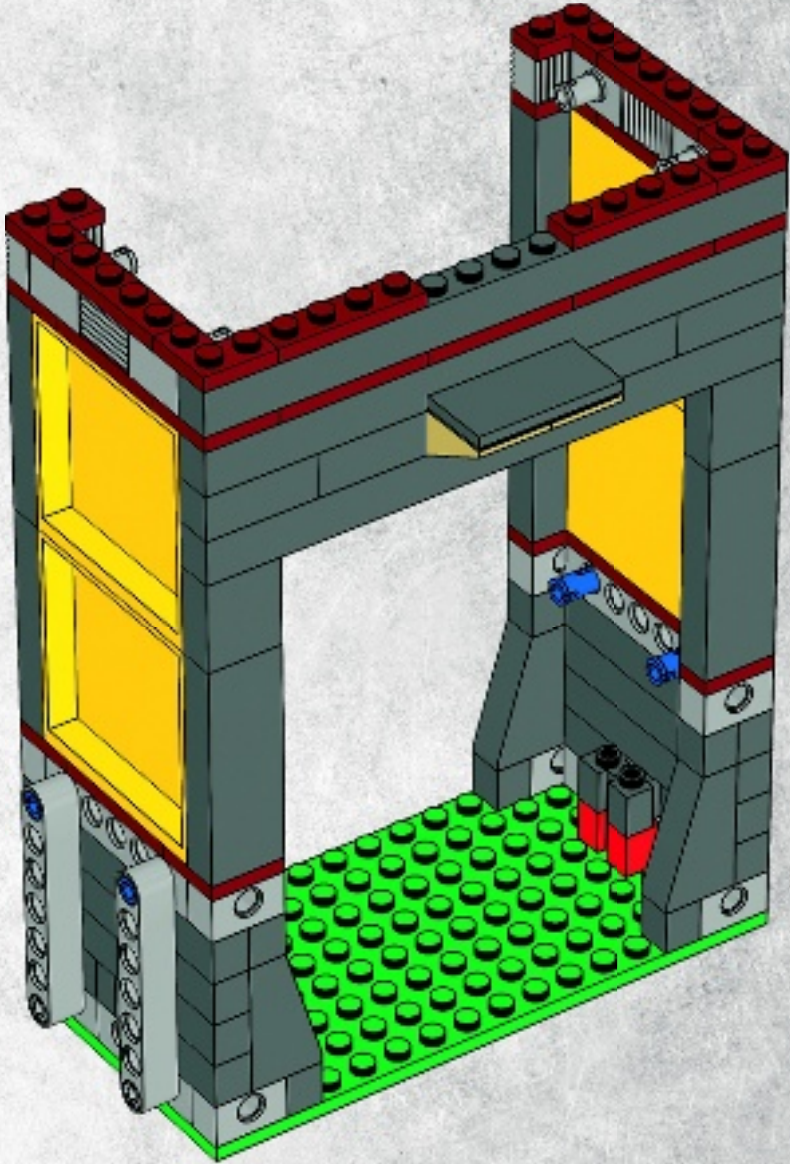

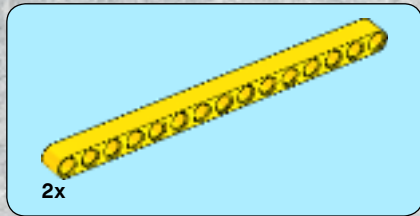

# 23

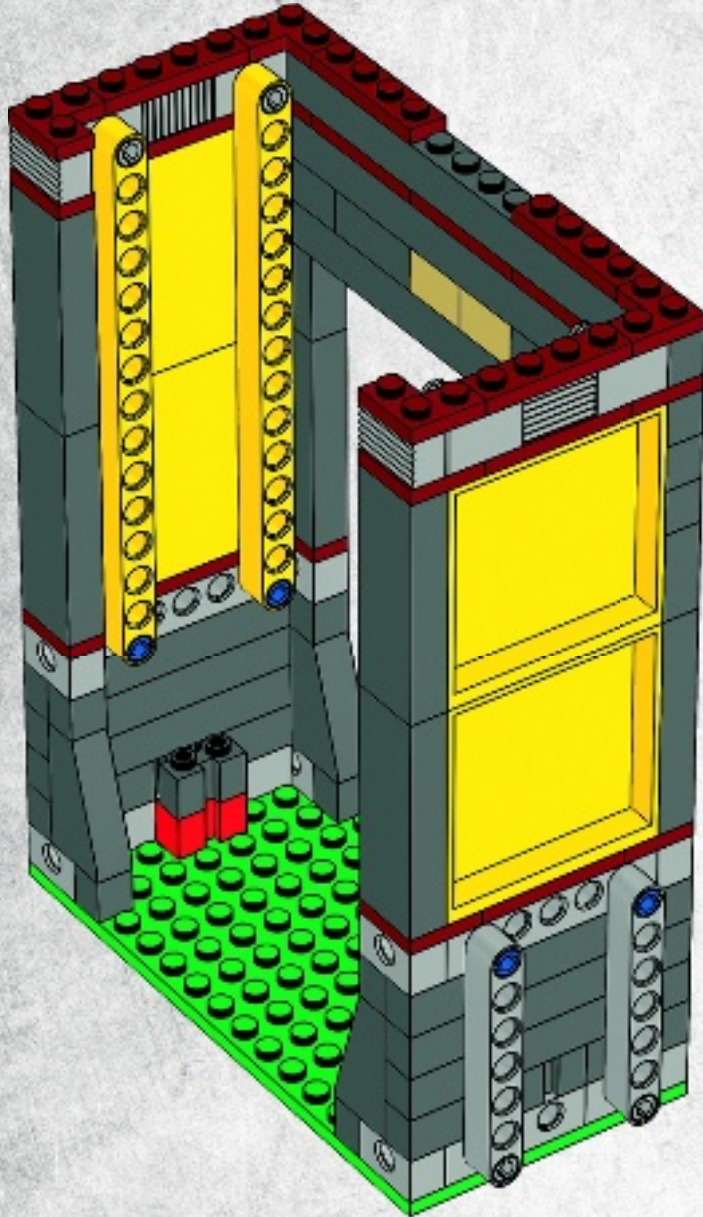

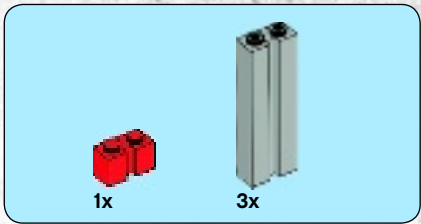

# 24

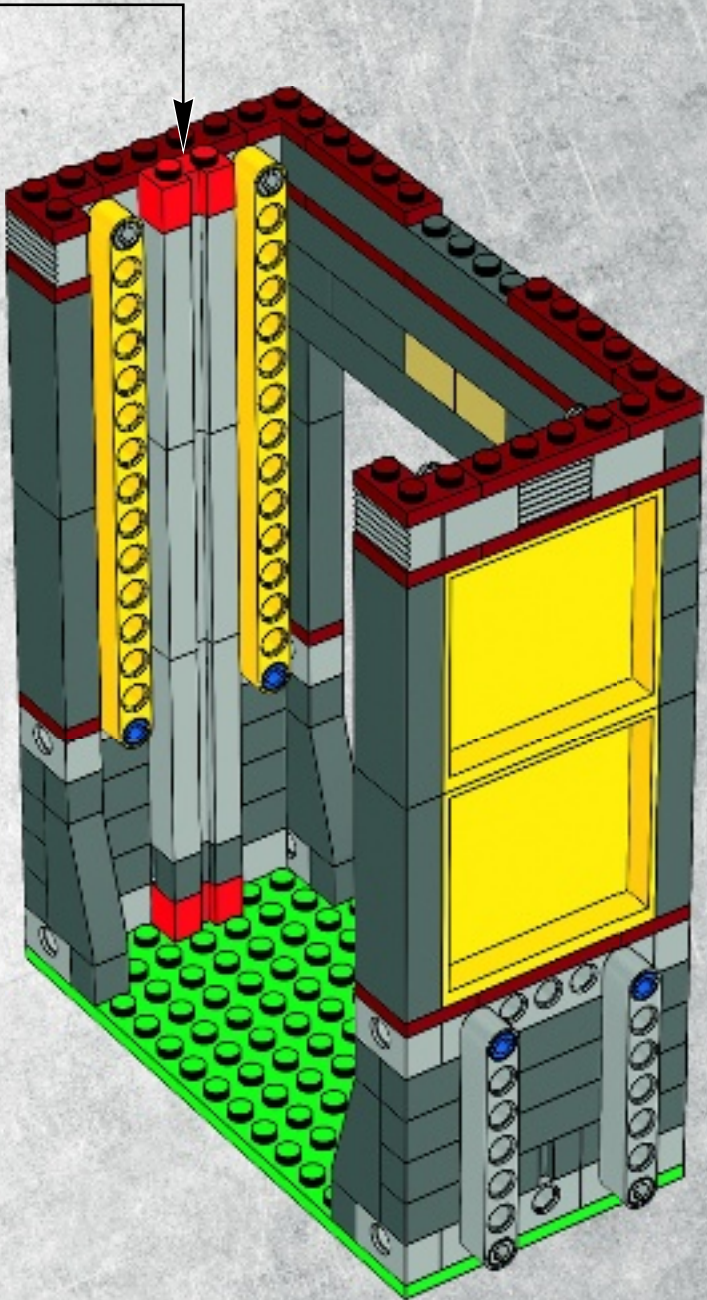
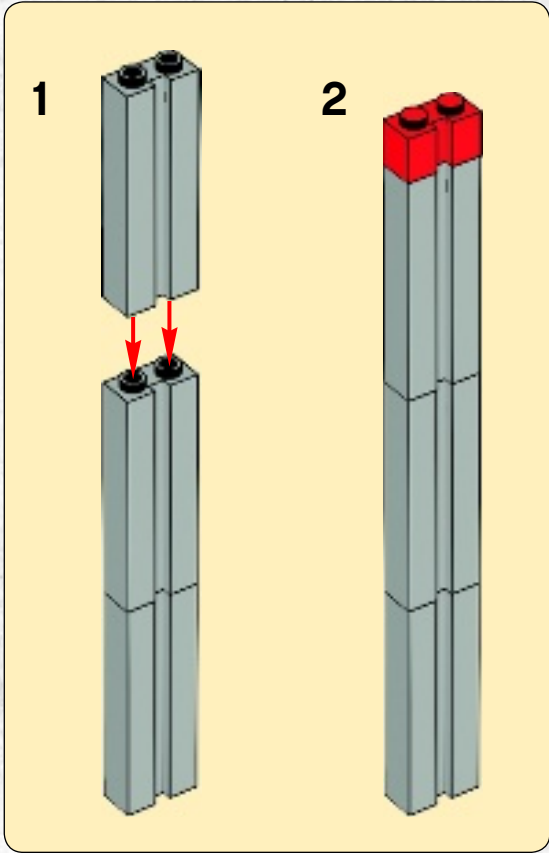



1x

# 25

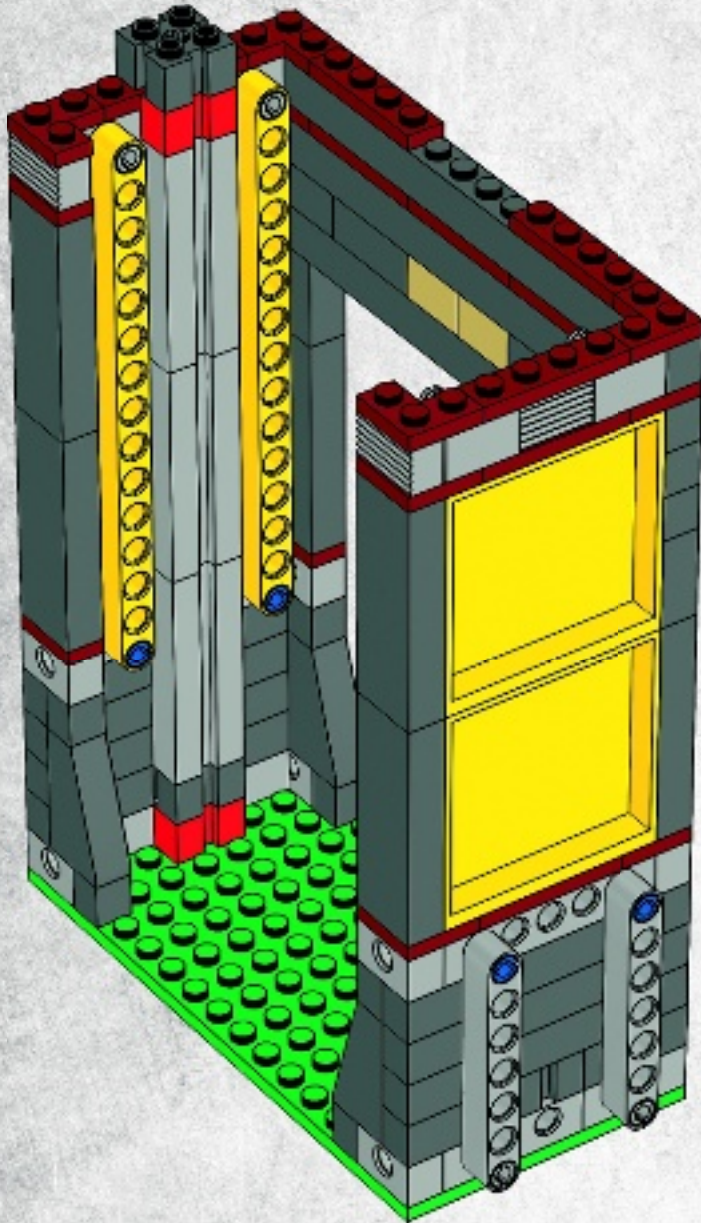



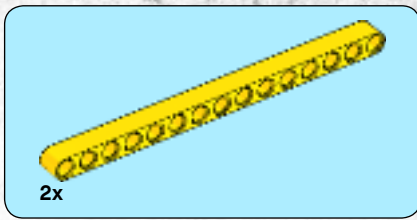

26

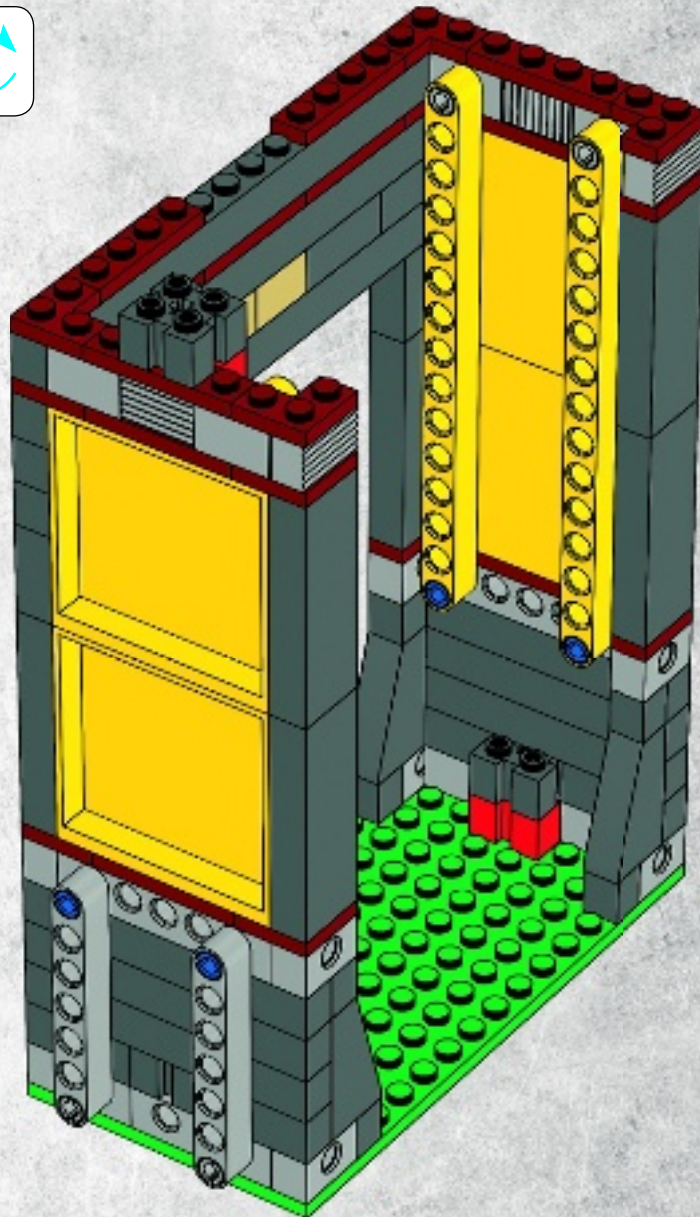
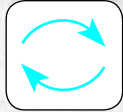

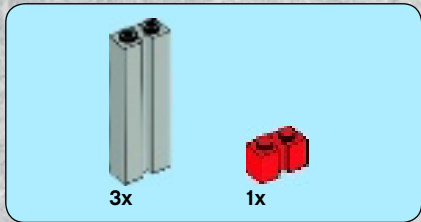

# 27

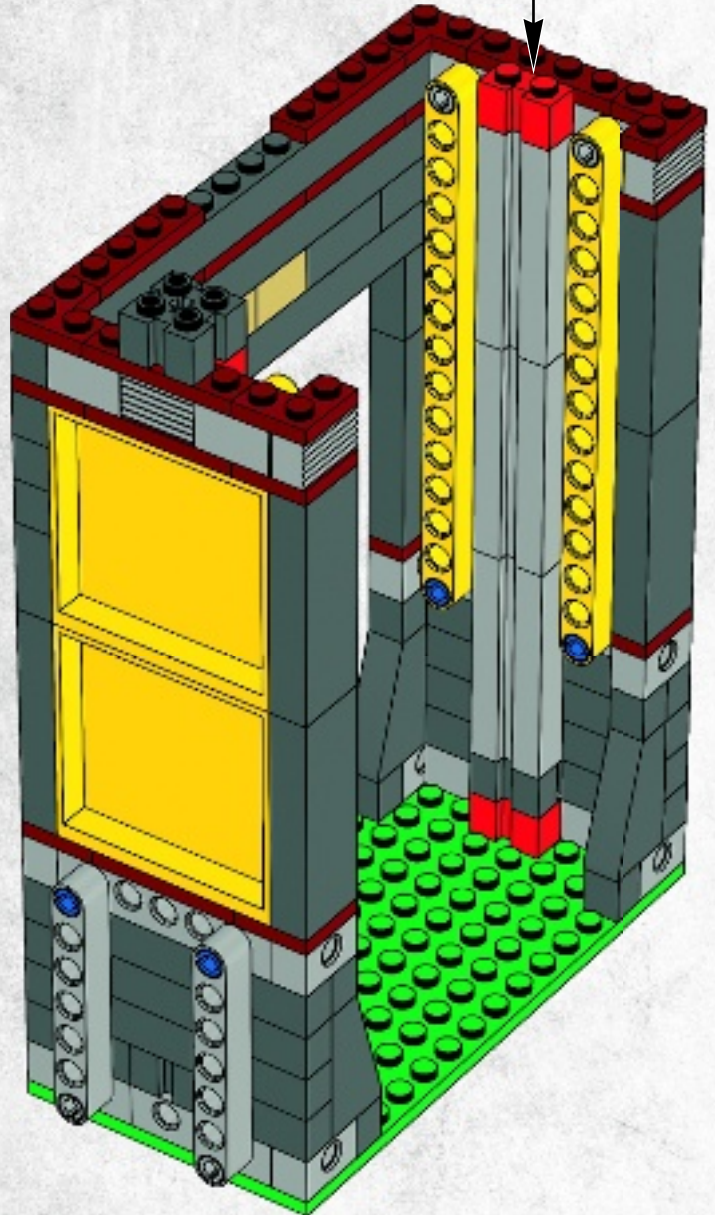
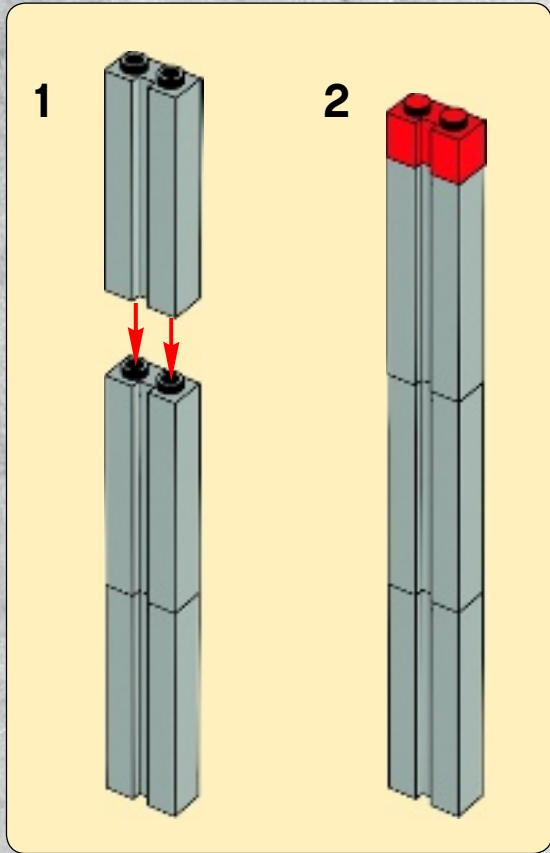



1x

# 28

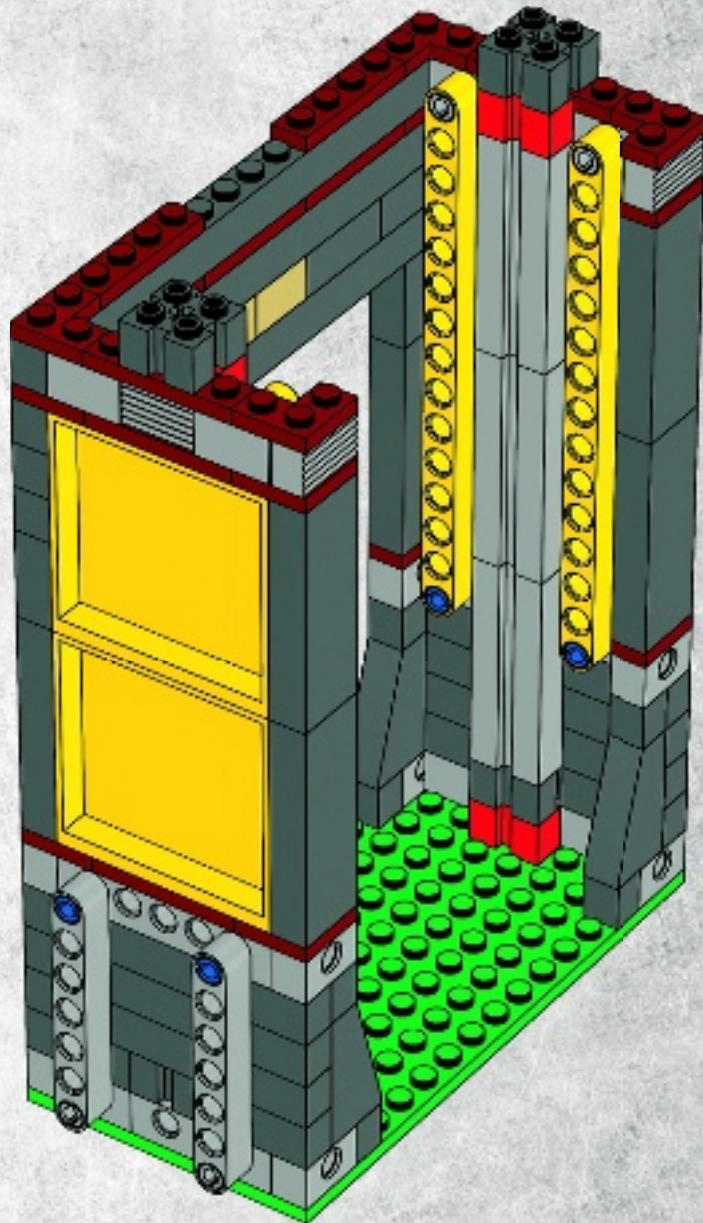

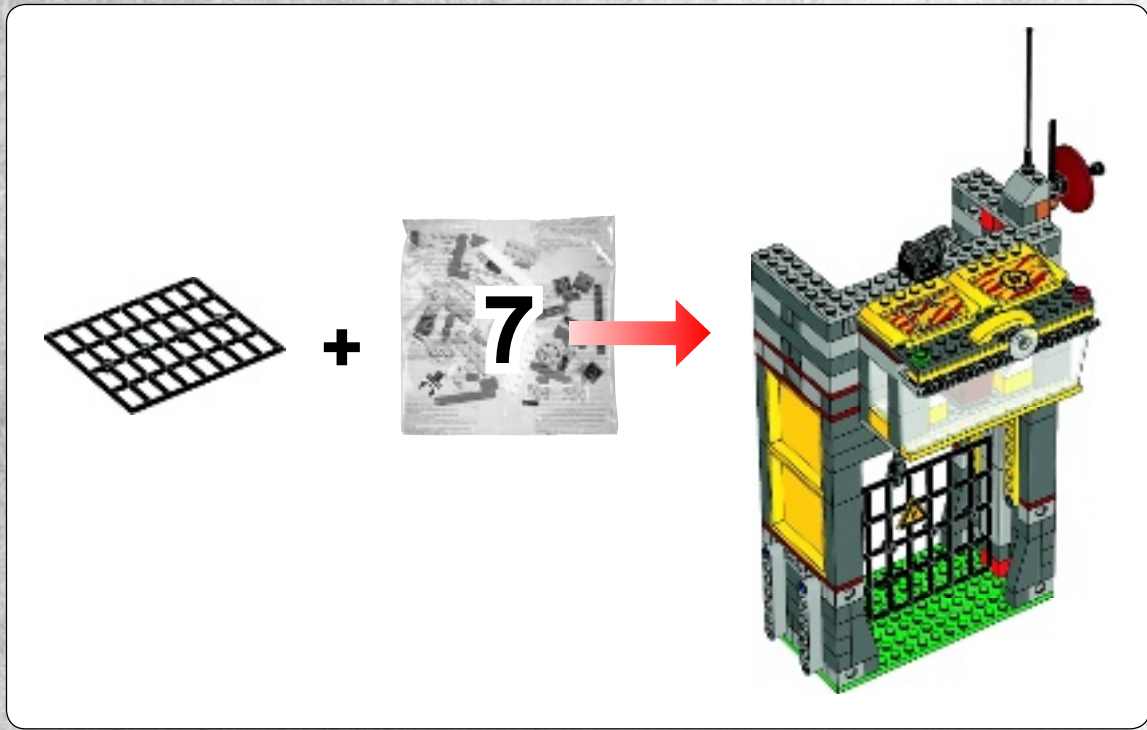

# 29

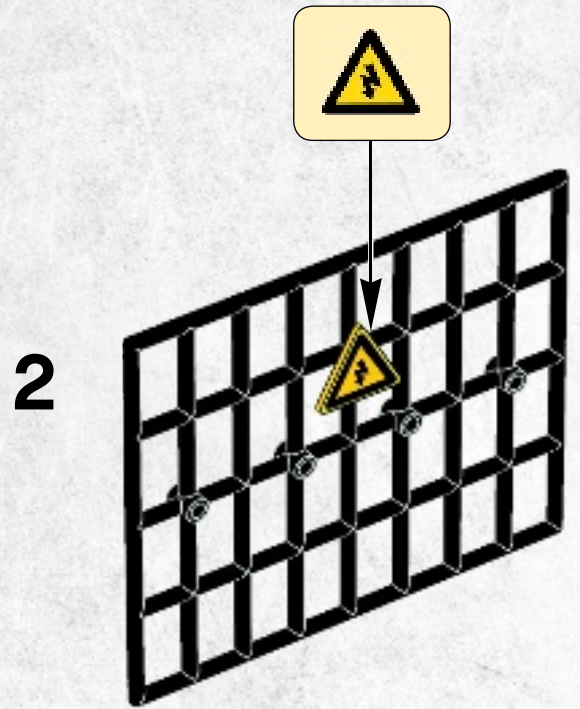
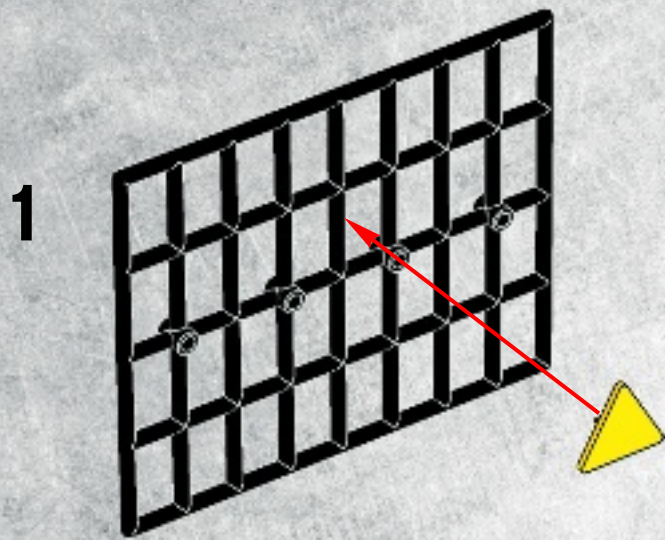

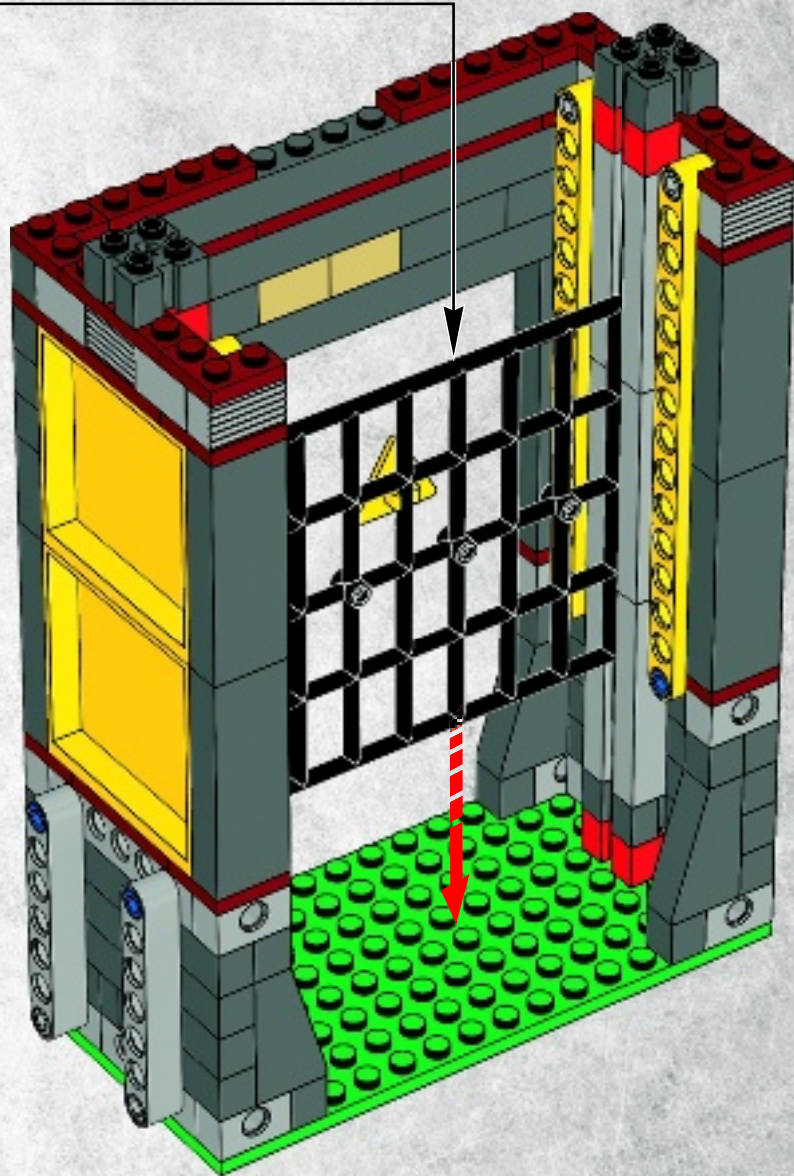

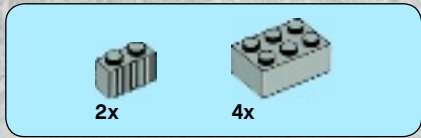

# 30

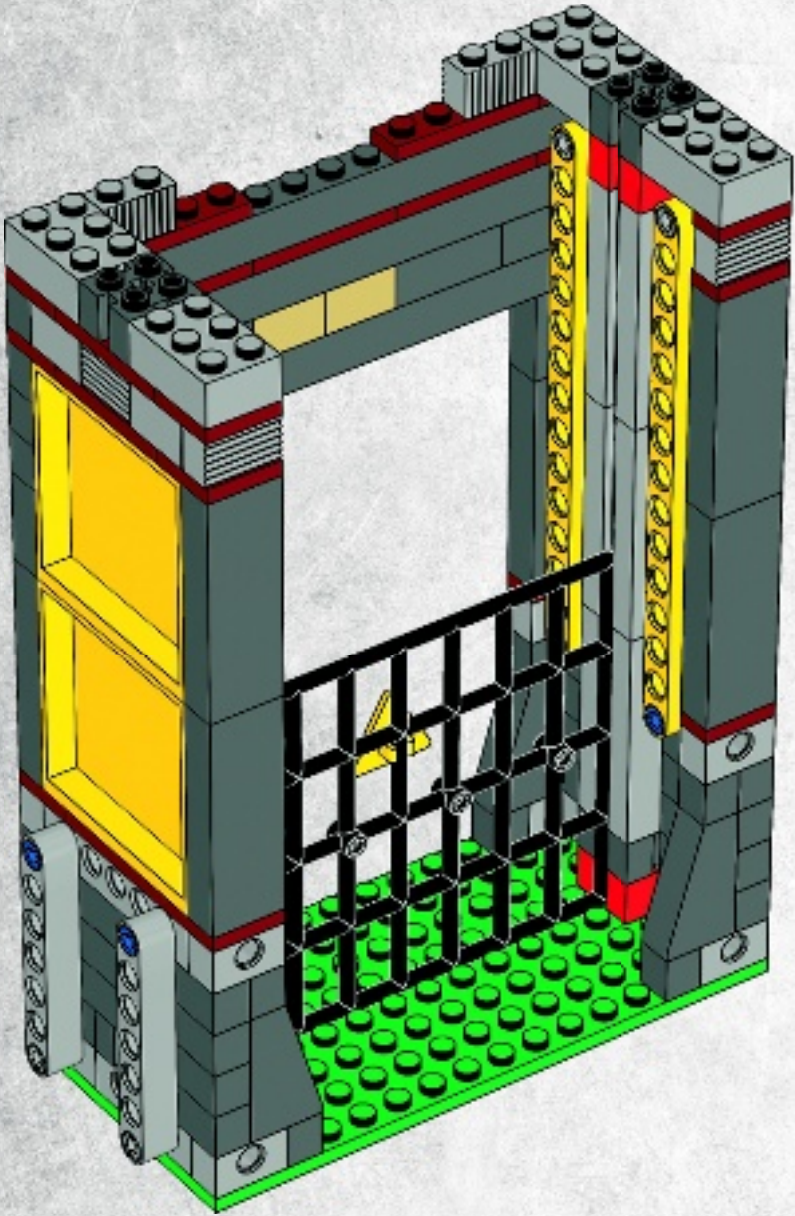

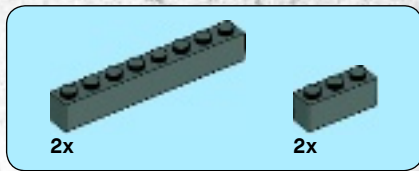

31

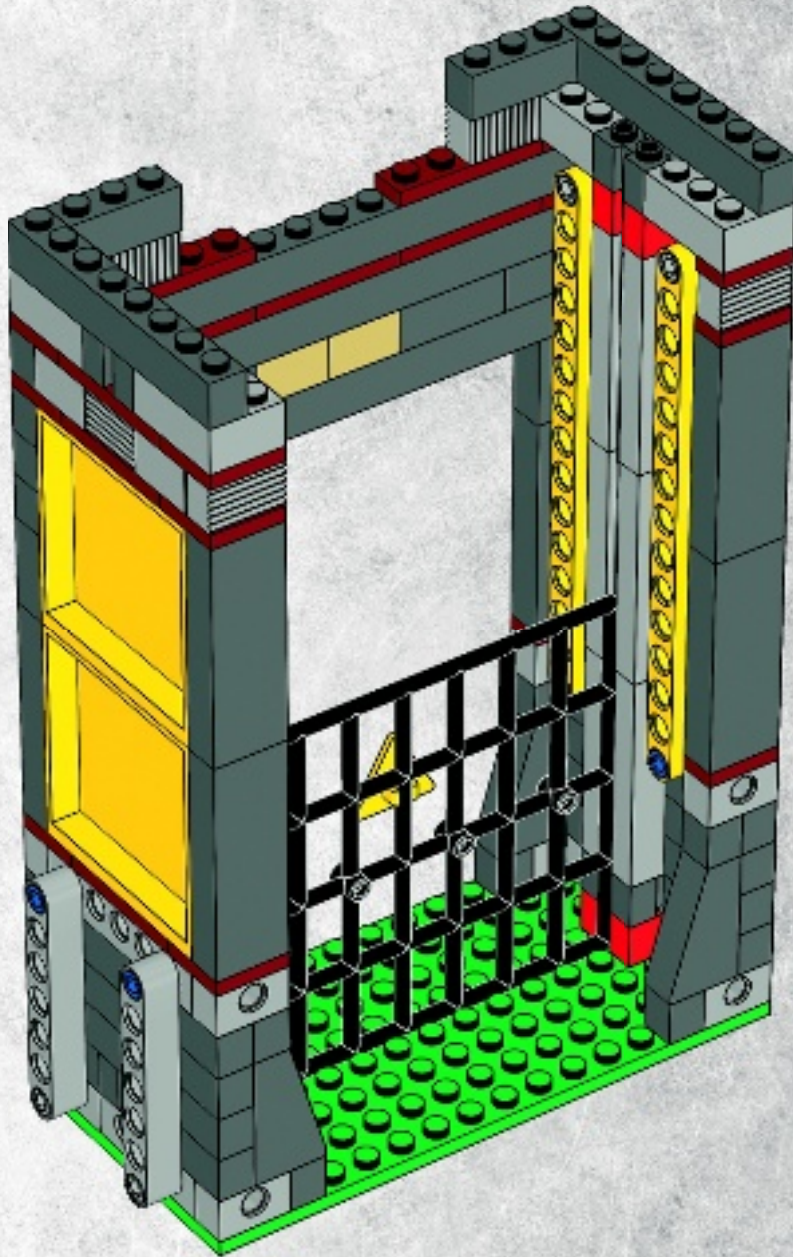



2x



2x

# 32

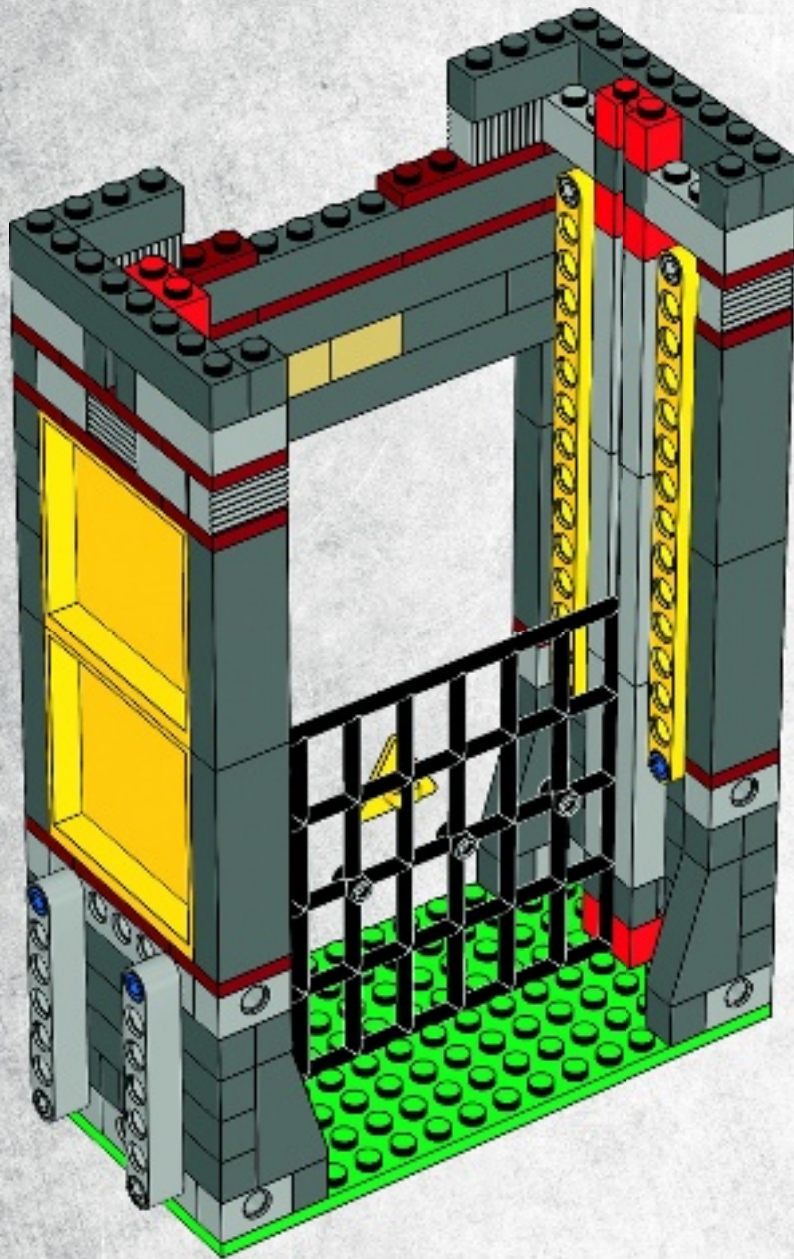



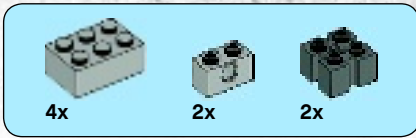

# 33

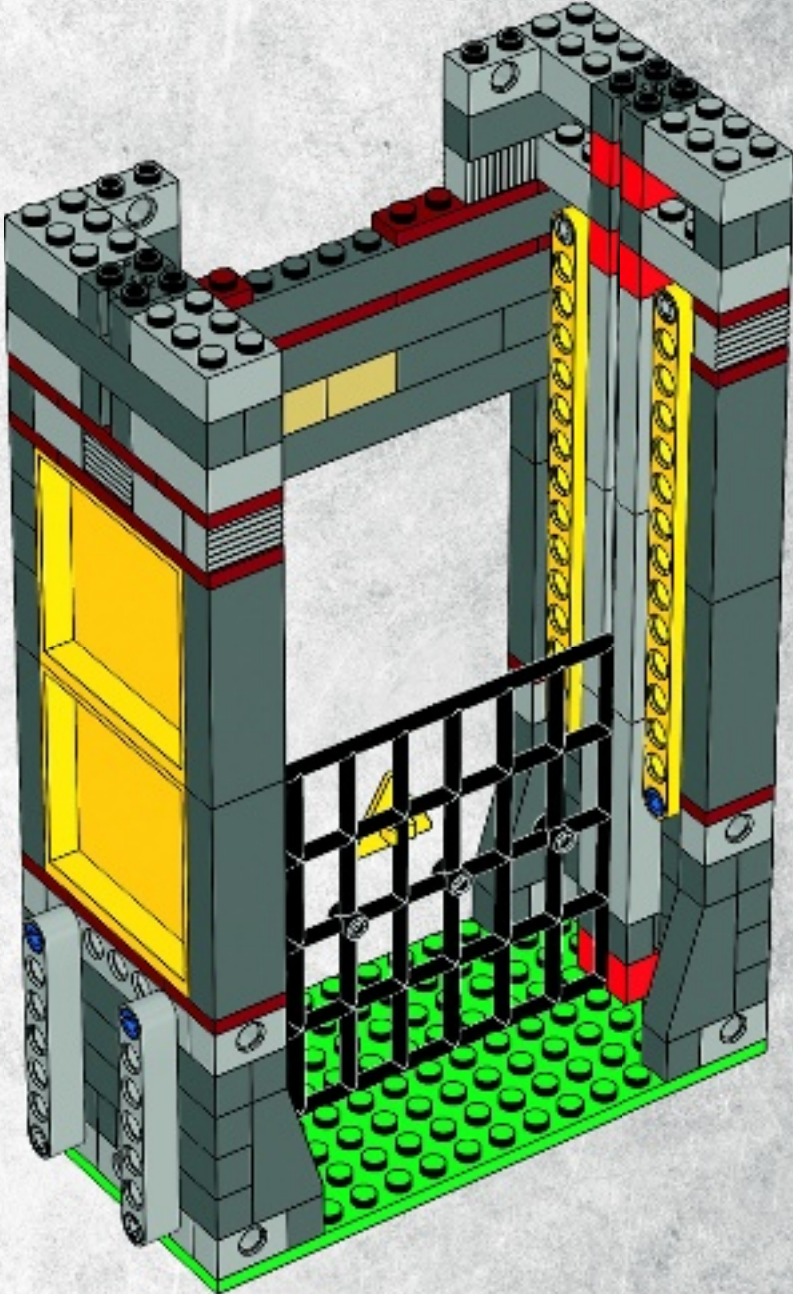

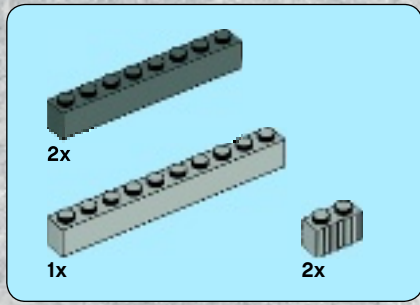

34

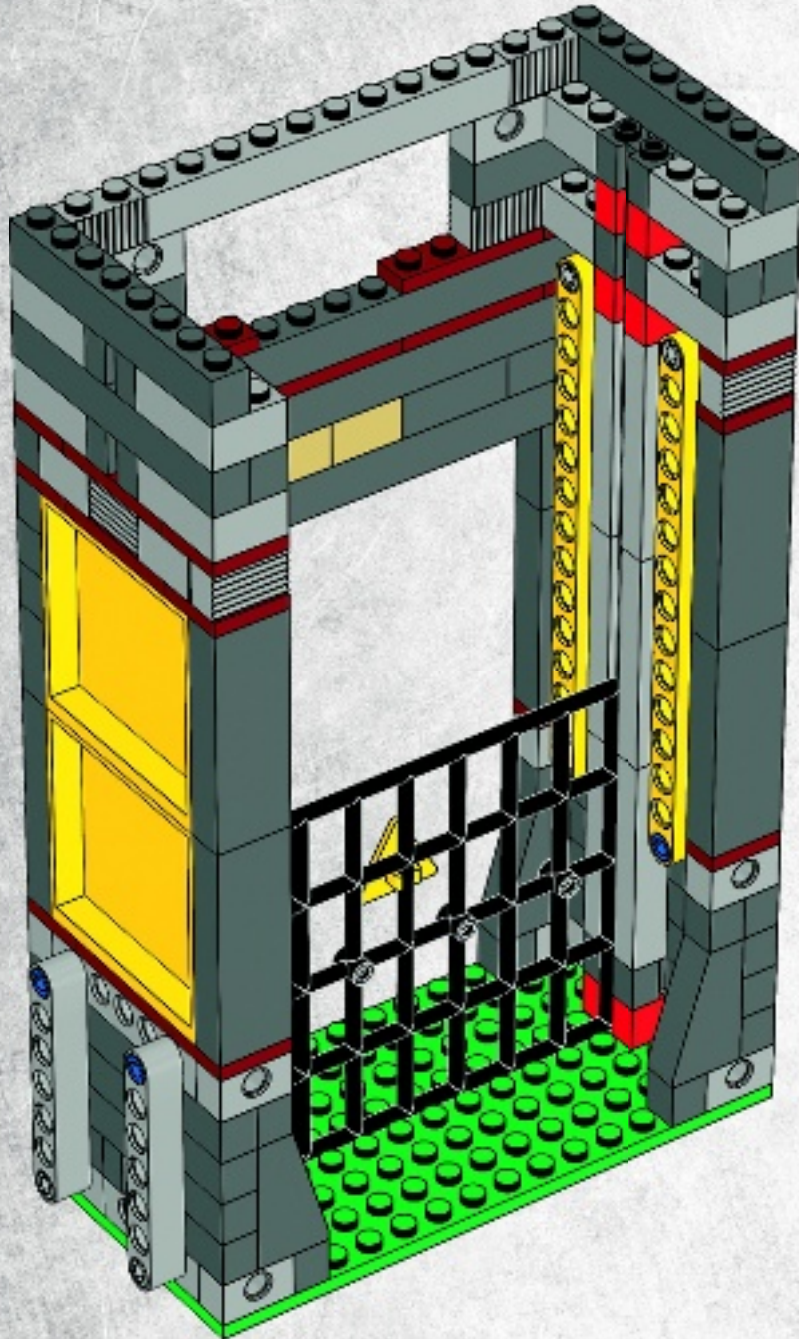



2x



2x

# 35

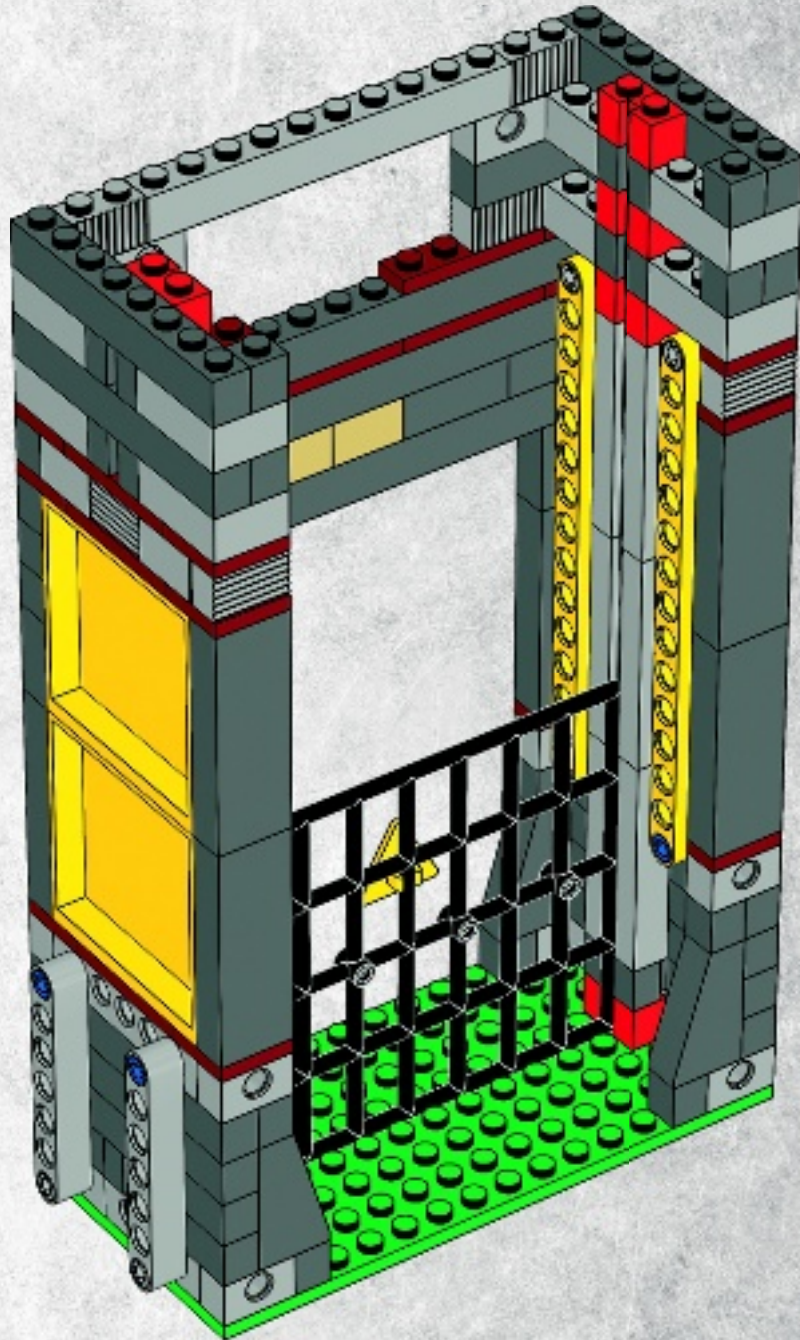

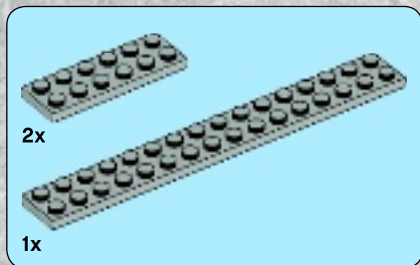

# 36

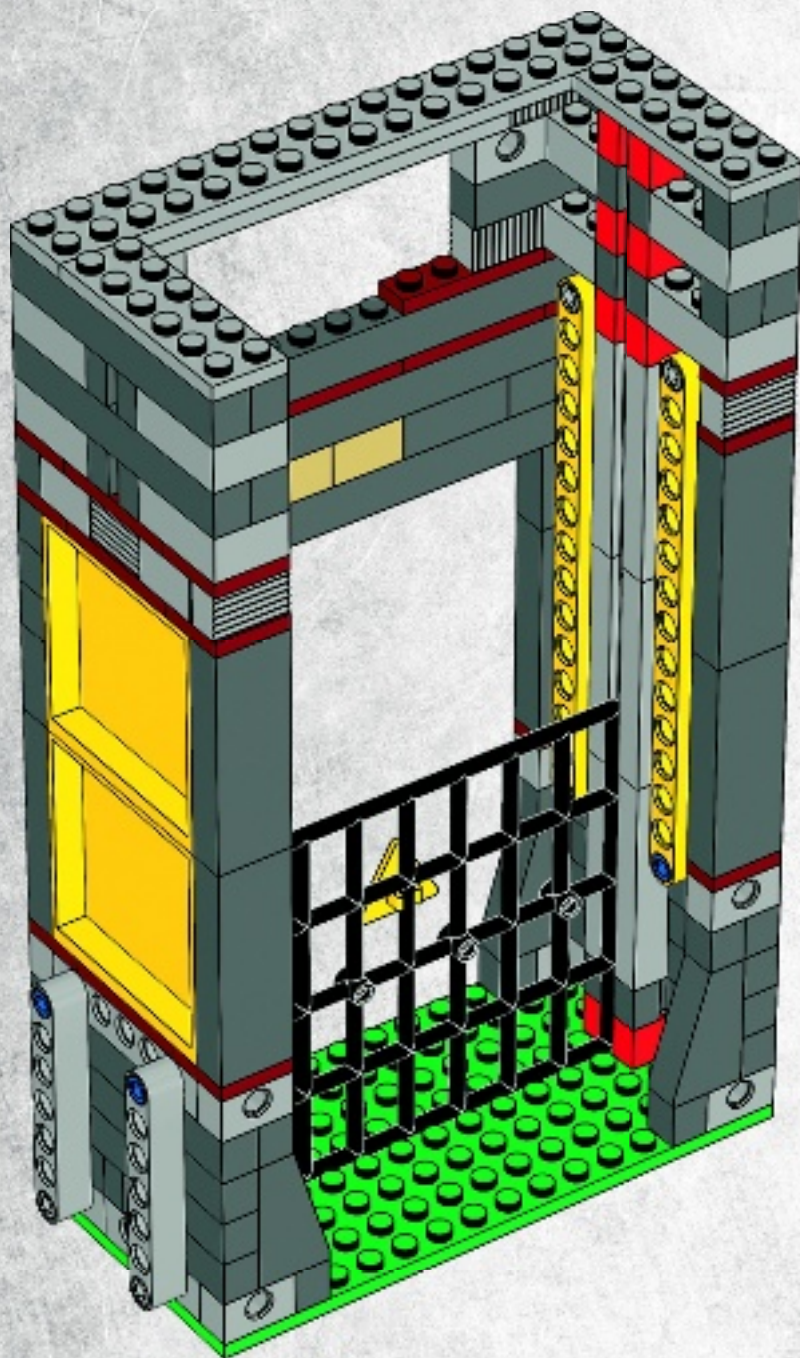

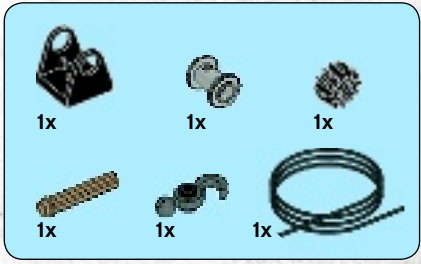

# 37

1

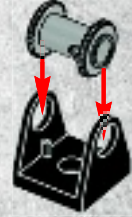

2

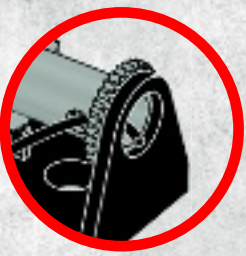

3

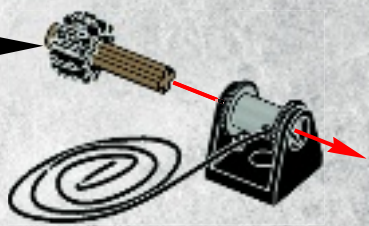
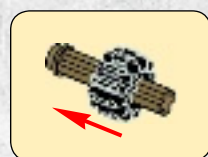

4

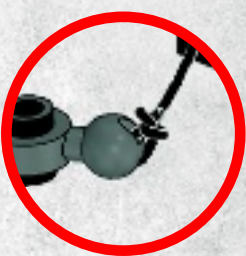

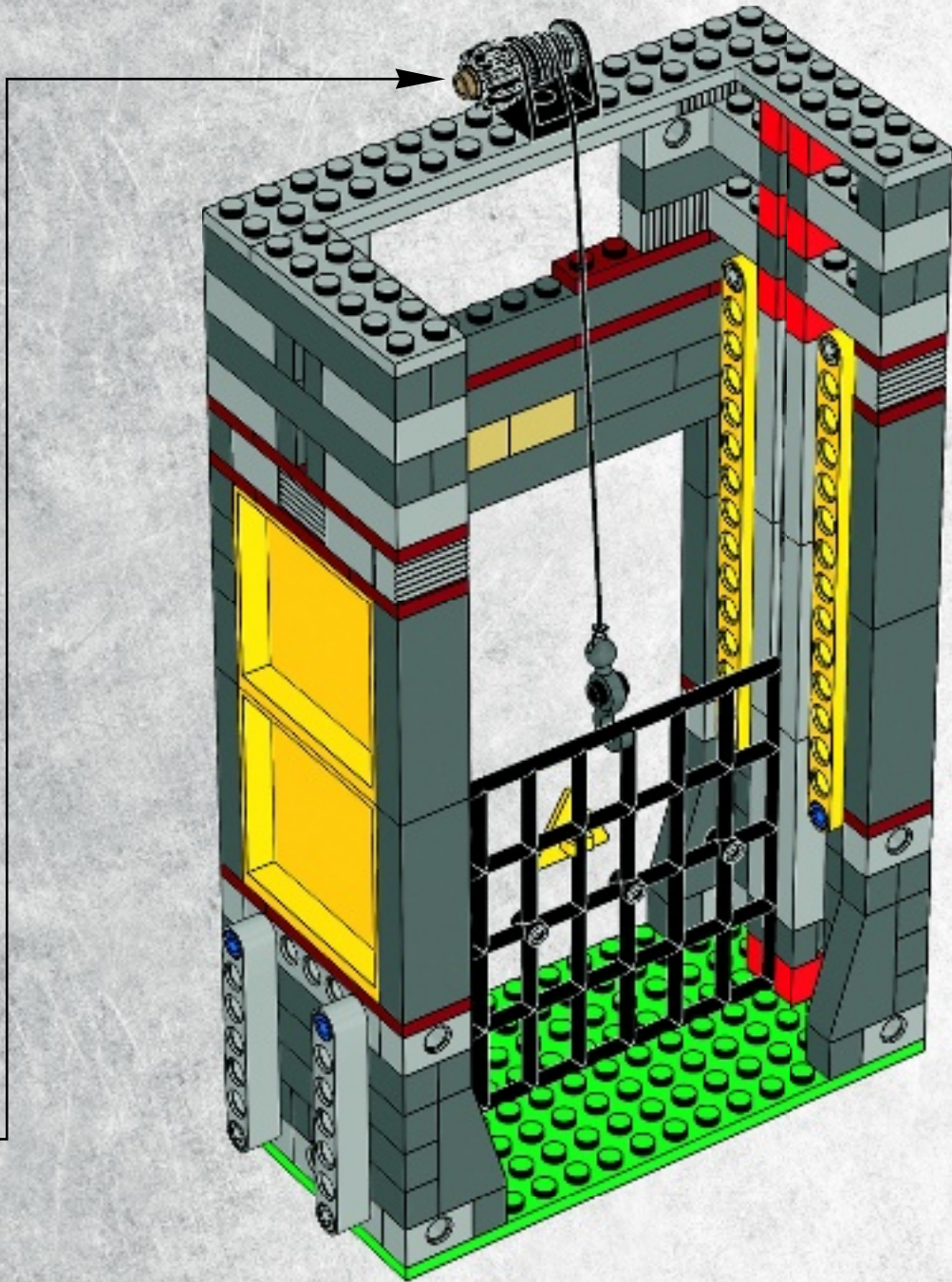

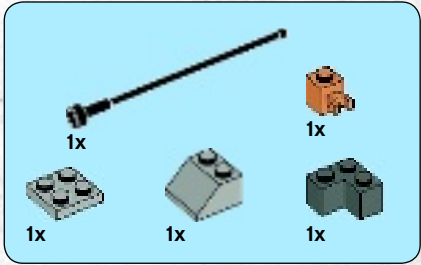

**38**

**1**

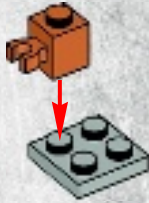

**2**



**3**



**4**



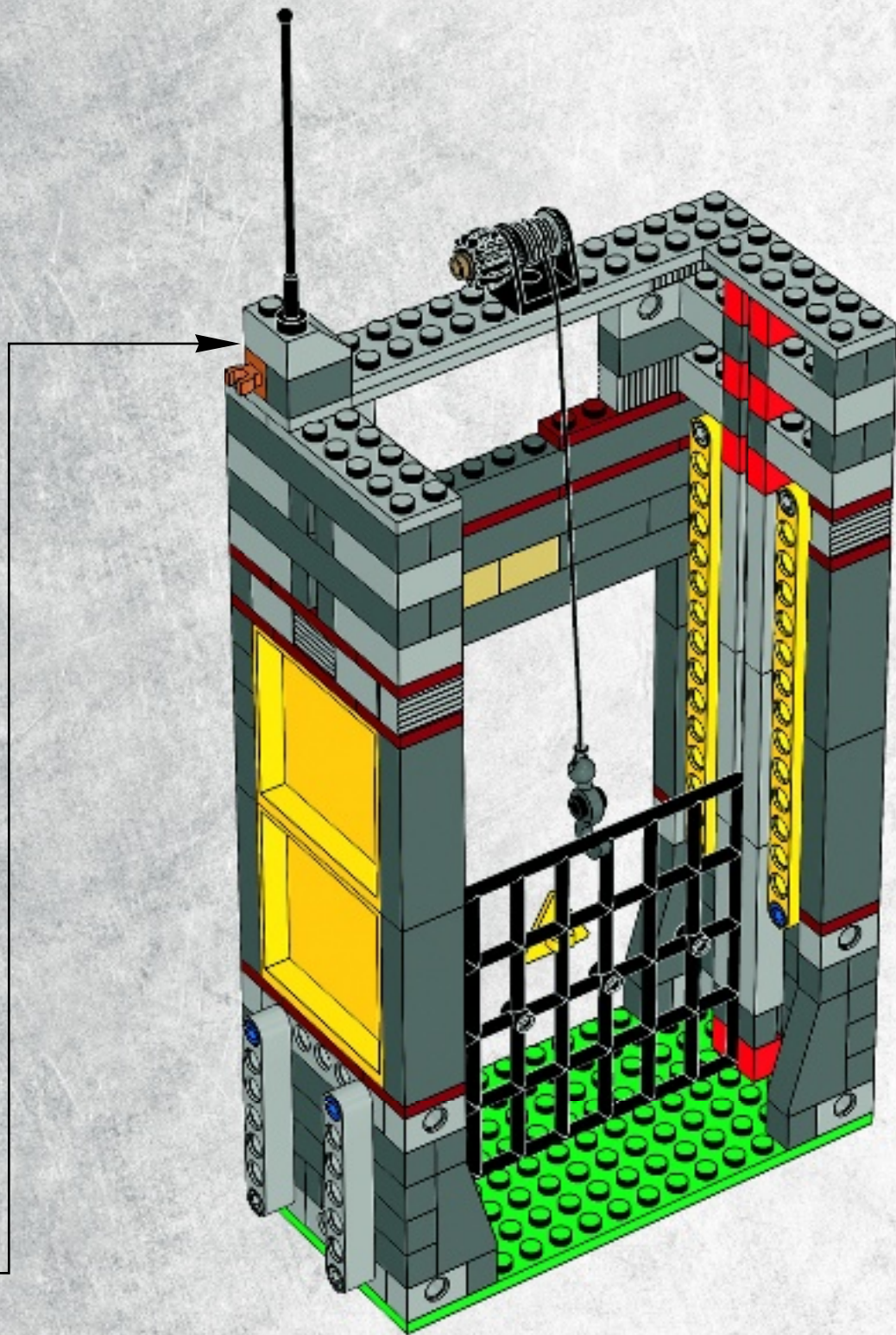



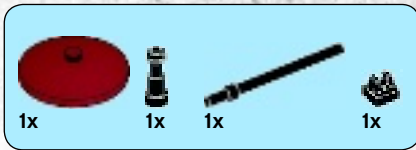

# 39

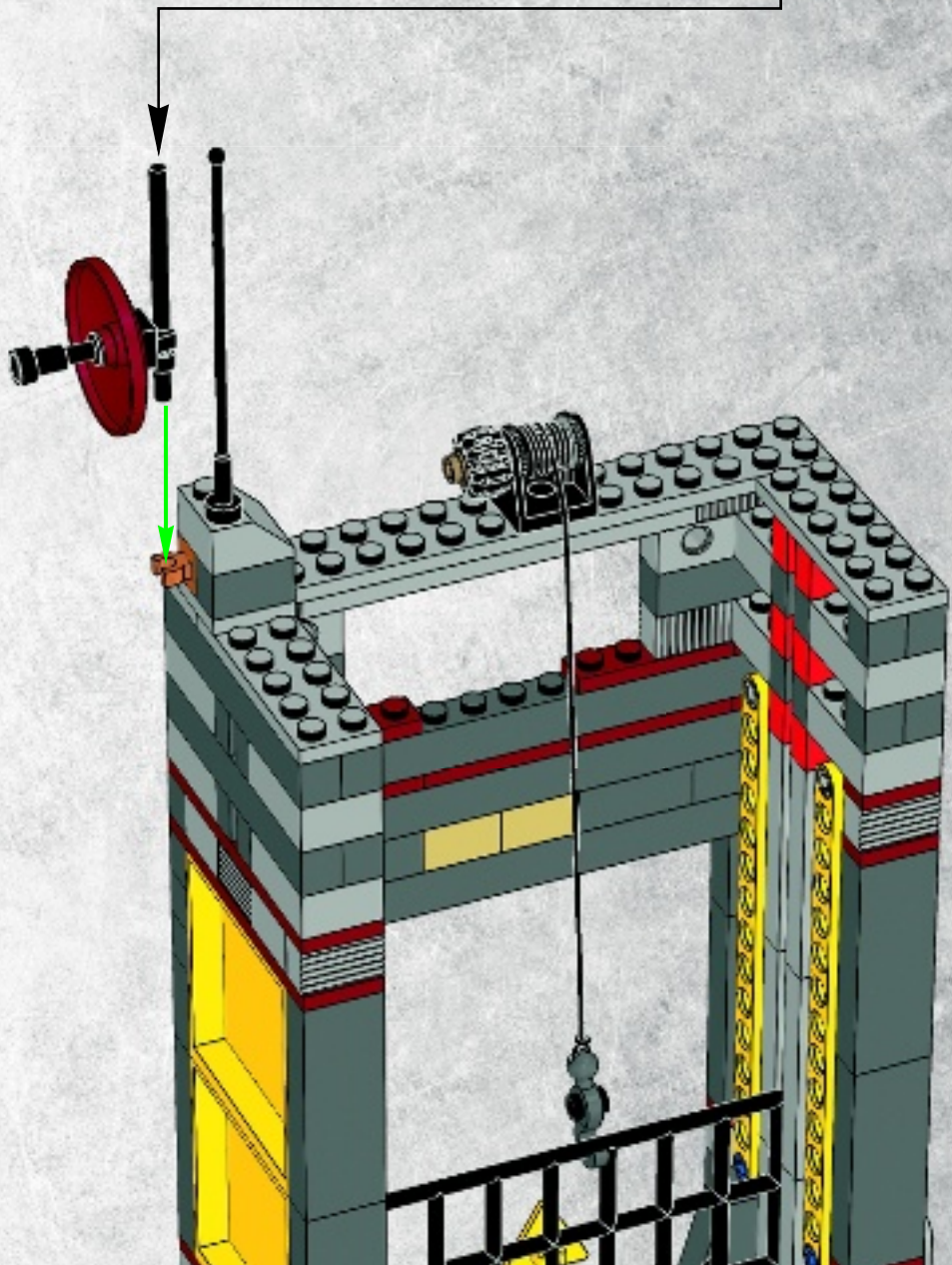
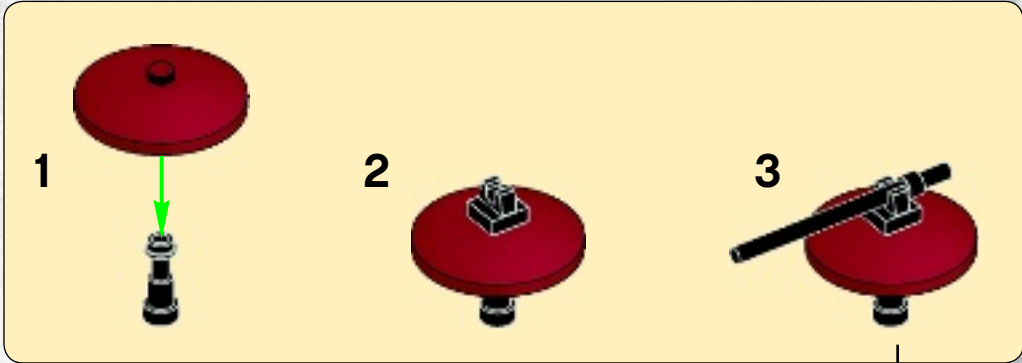

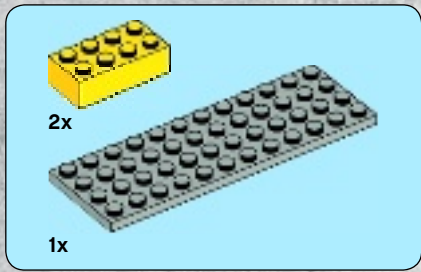

1

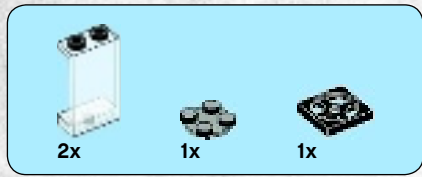
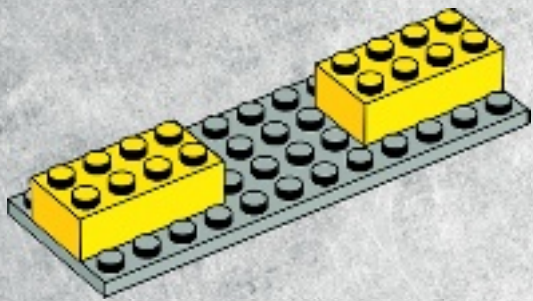

2

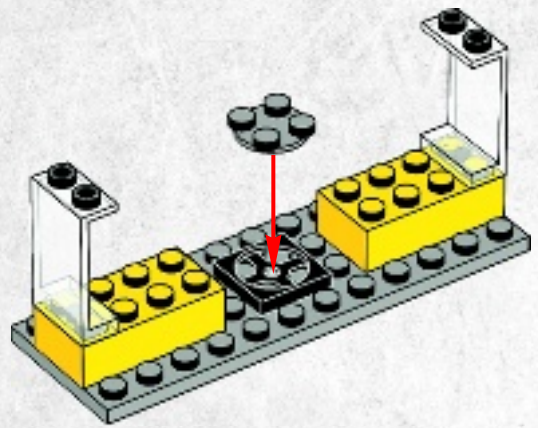



4

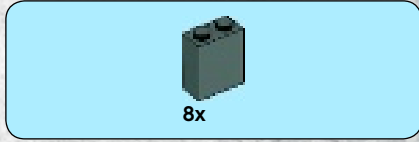
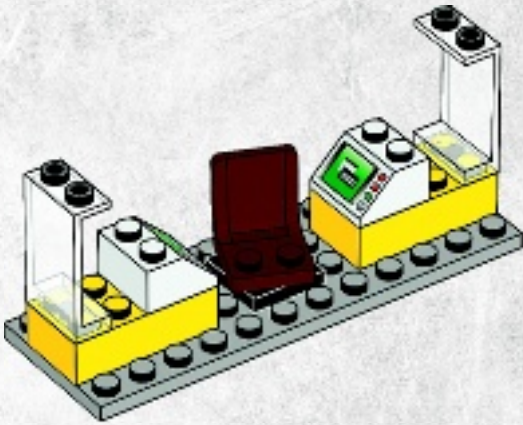

5

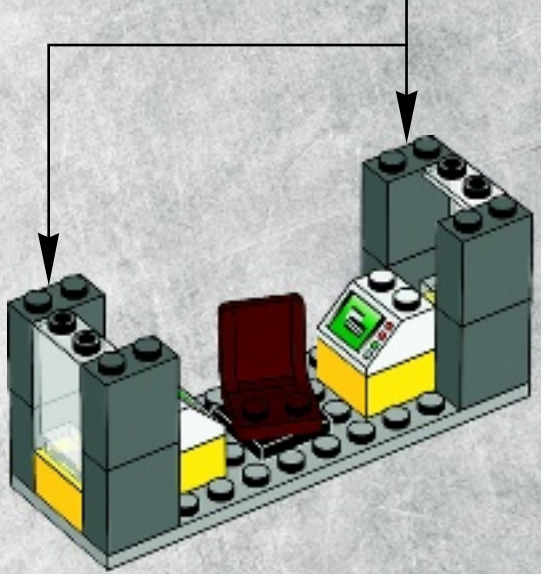
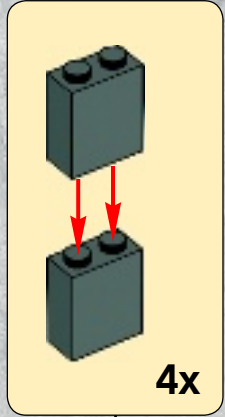

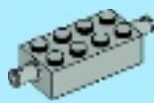

2x

6

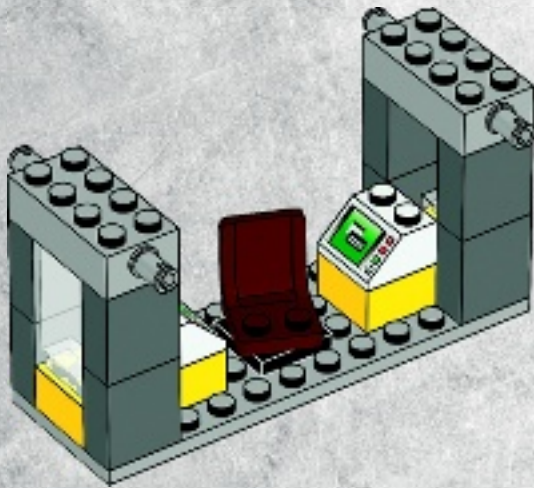

4x



2x

7

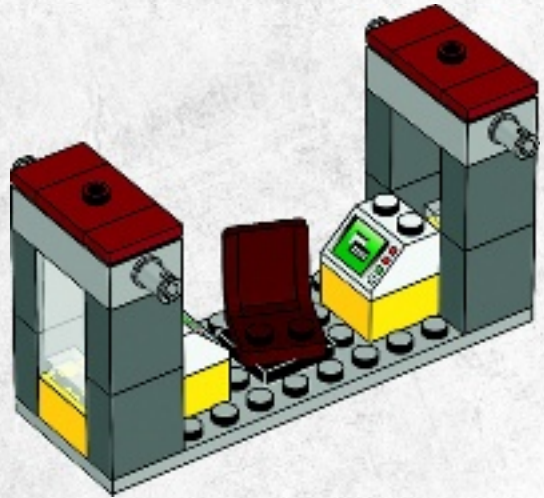

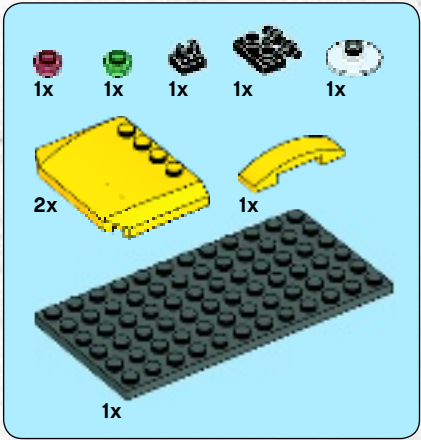

8

1

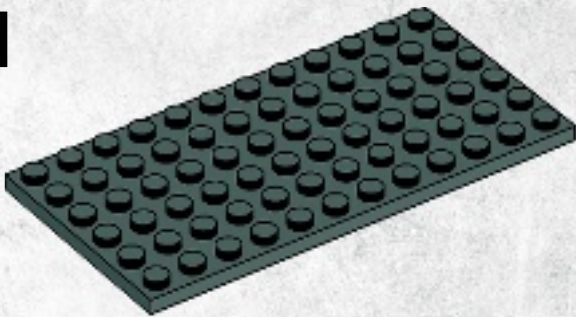

2



3

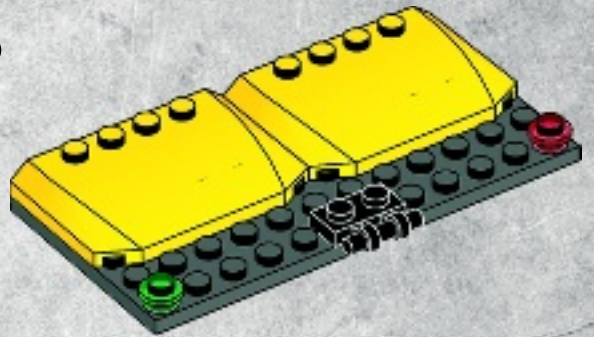

4



5

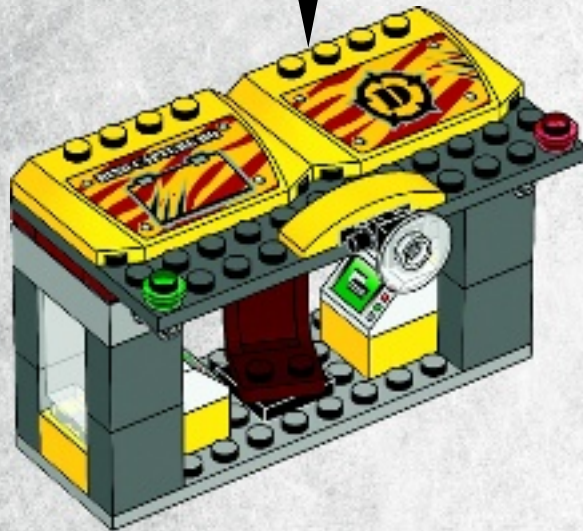
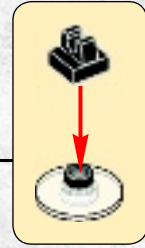

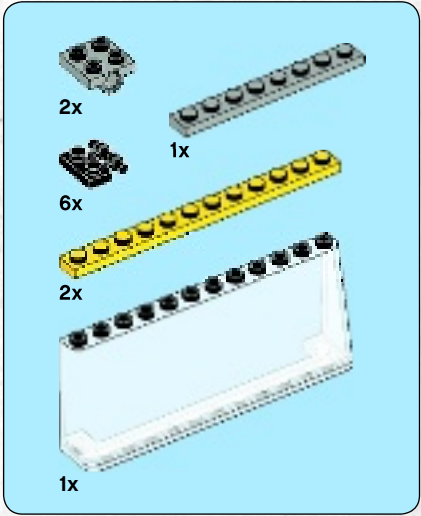

9

1

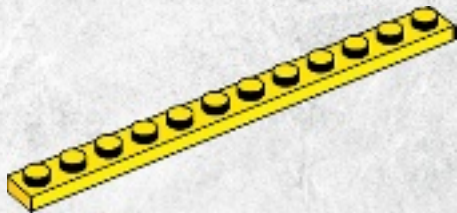

2

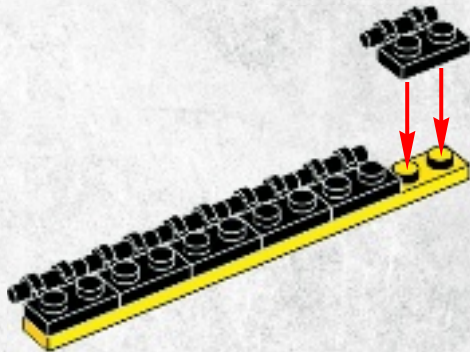

3

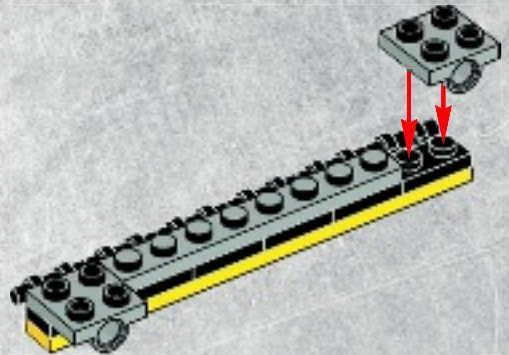

4

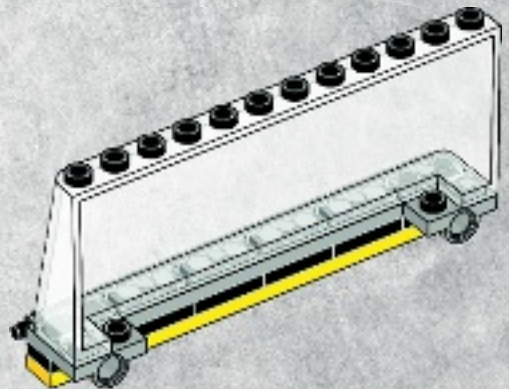

5

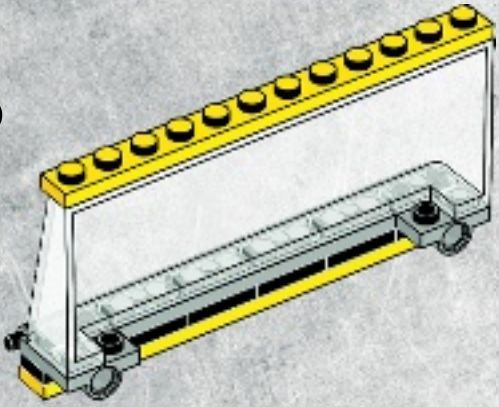

6

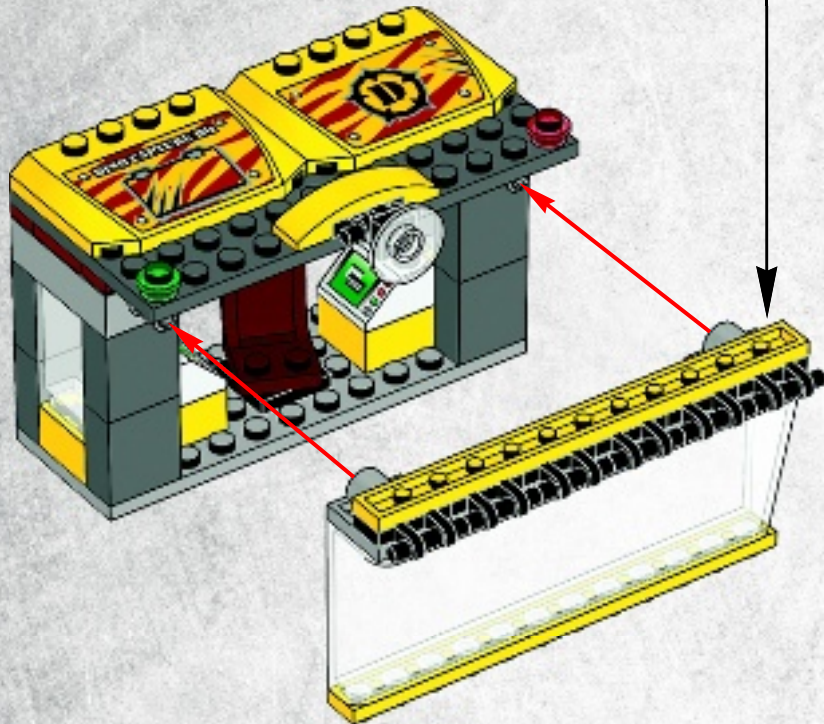
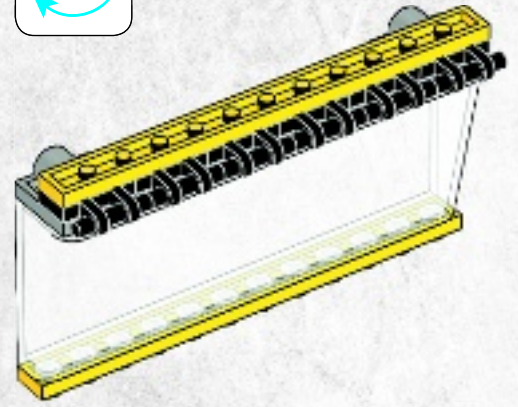
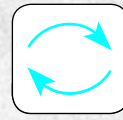



40

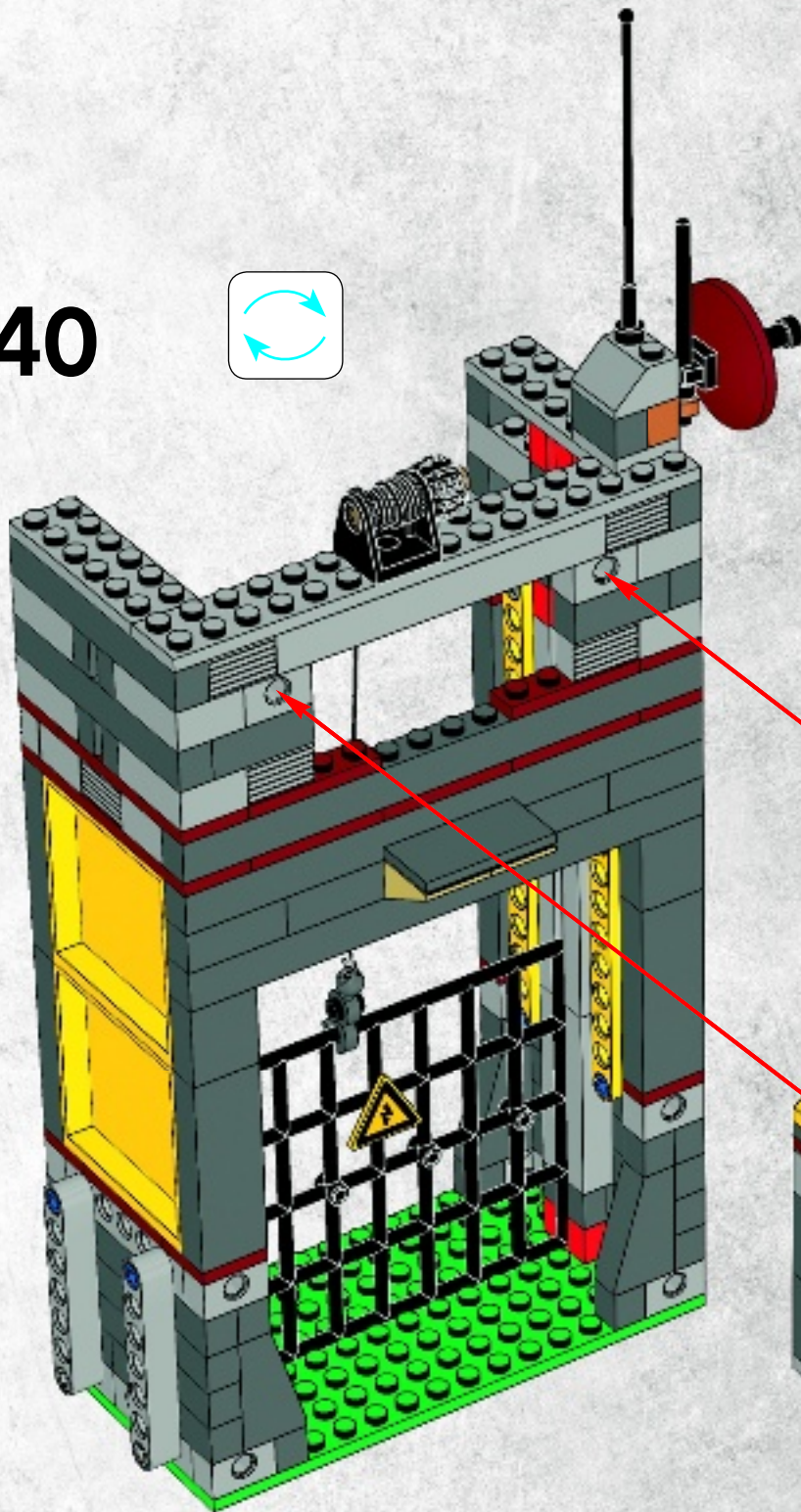
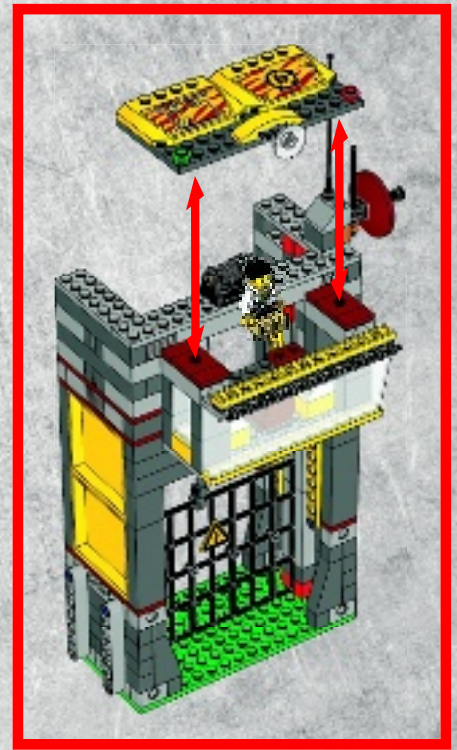
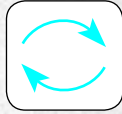

41





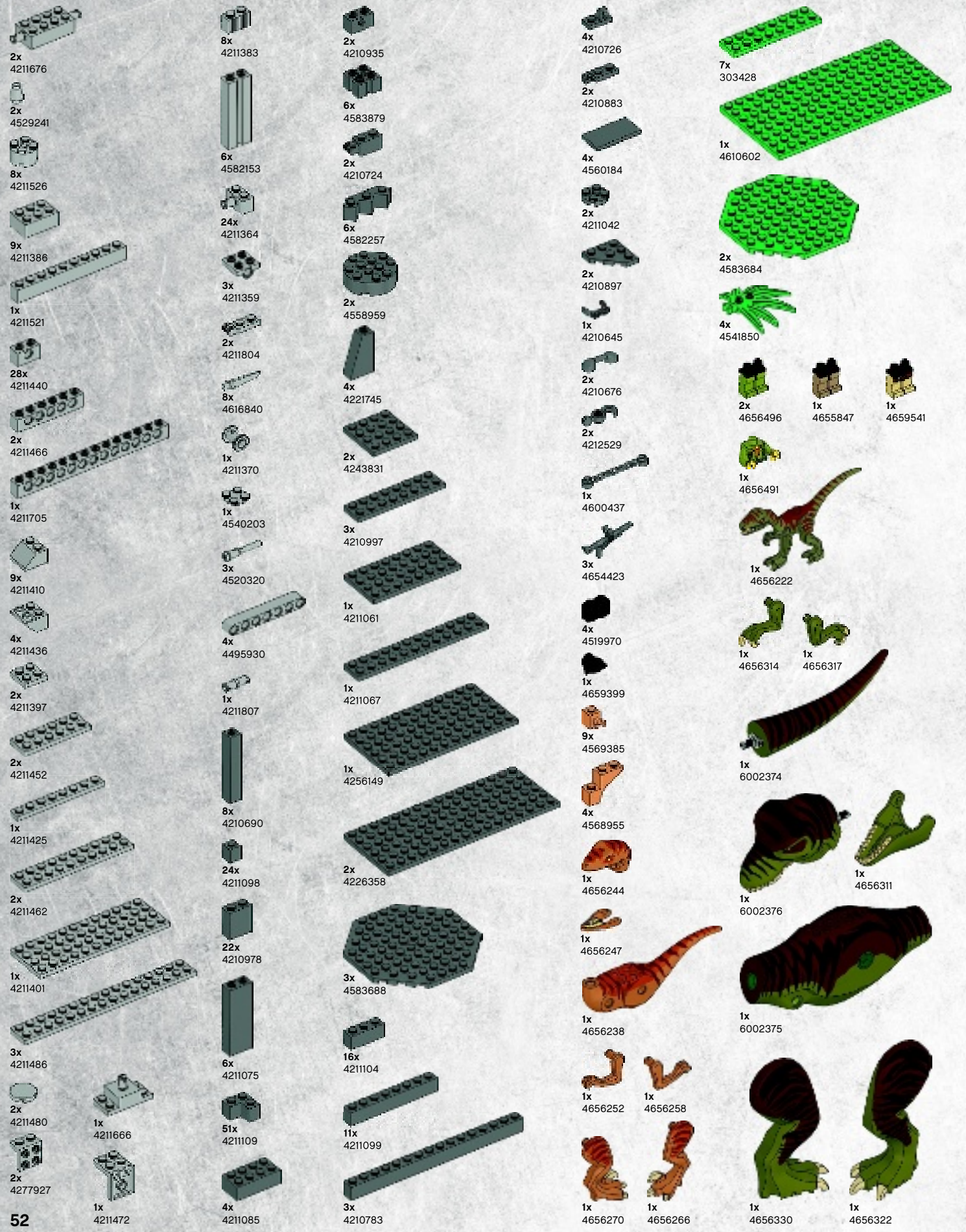

2x 4211676  
2x 4529241  
8x 4211526  
9x 4211386  
1x 4211521  
28x 4211440  
2x 4211466  
1x 4211705  
9x 4211410  
4x 4211436  
2x 4211397  
2x 4211452  
1x 4211425  
2x 4211462  
1x 4211401  
3x 4211486  
2x 4211480  
2x 4277927  
1x 4211666  
1x 4211472

8x 4211383  
6x 4582153  
24x 4211364  
3x 4211359  
2x 4211804  
8x 4616840  
1x 4211370  
1x 4540203  
3x 4520320  
4x 4495930  
1x 4211807  
8x 4210690  
24x 4211098  
22x 4210978  
6x 4211075  
51x 4211109  
4x 4211085

2x 4210935  
6x 4583879  
2x 4210724  
6x 4582257  
2x 4558959  
4x 4221745  
2x 4243831  
3x 4210997  
1x 4211061  
1x 4211067  
1x 4256149  
2x 4226358  
3x 4583688  
16x 4211104  
11x 4211099  
3x 4210783

4x 4210726  
2x 4210883  
4x 4560184  
2x 4211042  
2x 4210897  
1x 4210645  
2x 4210676  
2x 4212529  
1x 4600437  
3x 4654423  
4x 4519970  
1x 4659399  
9x 4569385  
4x 4568955  
1x 4656244  
1x 4656247  
1x 4656238  
1x 4656252  
1x 4656270

7x 303428  
1x 4610602  
2x 4583684  
4x 4541850  
2x 4656496  
1x 4655847  
1x 4659541  
1x 4656491  
1x 4656222  
1x 4656314  
1x 4656317  
1x 6002374  
1x 6002376  
1x 6002375  
1x 4656238  
1x 4656258  
1x 4656270  
1x 4656266

1x 4656496  
1x 4655847  
1x 4659541  
1x 4656491  
1x 4656222  
1x 4656314  
1x 4656317  
1x 6002374  
1x 6002376  
1x 6002375  
1x 4656238  
1x 4656258  
1x 4656270  
1x 4656266

1x 4656496  
1x 4655847  
1x 4659541  
1x 4656491  
1x 4656222  
1x 4656314  
1x 4656317  
1x 6002374  
1x 6002376  
1x 6002375  
1x 4656238  
1x 4656258  
1x 4656270  
1x 4656266



1x 4195657  
 1x 4195659  
 1x 4659347  
 4x 4162465  
 2x 4114319  
 2x 4500453  
 2x 4113917  
 2x 4114309  
 1x 4278422  
 1x 4659595  
 1x 407021  
 8x 4501560  
 2x 379521  
 2x 4588003  
 1x 613421  
 1x 4597902  
 1x 4163290  
 1x 393724  
 2x 4107066  
 4x 4542579

16x 300424  
 4x 4506845  
 16x 4581524  
 2x 4503844  
 1x 4549996  
 2x 4270871  
 2x 4188357  
 5x 4613151  
 4x 4522035  
 3x 4185617  
 15x 300324  
 2x 301024  
 4x 300124  
 4x 300924  
 3x 4271082  
 2x 4514844

5x 379424  
 2x 4535740  
 2x 614124  
 3x 74156  
 3x 4655574  
 1x 4655810  
 1x 4613584  
 1x 4654328  
 1x 4657964  
 4x 4170460  
 6x 4539435  
 5x 4506556  
 6x 4653818  
 2x 4171666  
 2x 4263142  
 1x 4655576  
 2x 4185269

2x 4656281  
 1x 4562148  
 1x 4121715  
 1x 370526  
 1x 4177431  
 3x 4538456  
 3x 255526  
 1x 241226  
 13x 4140588  
 1x 4613759  
 1x 4514342  
 4x 4192456  
 1x 243226  
 1x 408326  
 13x 658326  
 3x 4653790  
 1x 71155

1x 4538722  
 1x 256926  
 1x 4653226  
 2x 396226  
 1x 452226  
 1x 400626  
 4x 4568644  
 4x 448826  
 1x 4198998  
 1x 4599984  
 1x 247926  
 1x 4507820  
 1x 368026  
 1x 258426  
 2x 4517986  
 1x 4297719

25x 4613761  
 12x 4585751  
 17x 4539061  
 28x 4539090  
 4x 4539083  
 1x 4541544  
 1x 4541386  
 1x 4655815  
 2x 4541493  
 8x 4626928  
 4x 4211152  
 1x 4211189  
 1x 4211206  
 1x 4211185  
 2x 4507049

1x 9566  
 4x 4514553  
 3x 4654583  
 1x 4566927  
 2x 3005741  
 2x 3005748  
 6x 4567334  
 2x 611649  
 2x 4626724  
 4x 3005740  
 3x 4187750  
 2x 4113106  
 4x 4100381  
 2x 4546690  
 1x 4655580

  
**Customer Service**  
**Kundenservice**  
**Service Consommateurs**  
**Servicio Al Consumidor**  
[www.lego.com/service](http://www.lego.com/service) or dial  
 : 00800 5346 5555  
 : 1-800-422-5346

5882



5884



5883



5885



5886

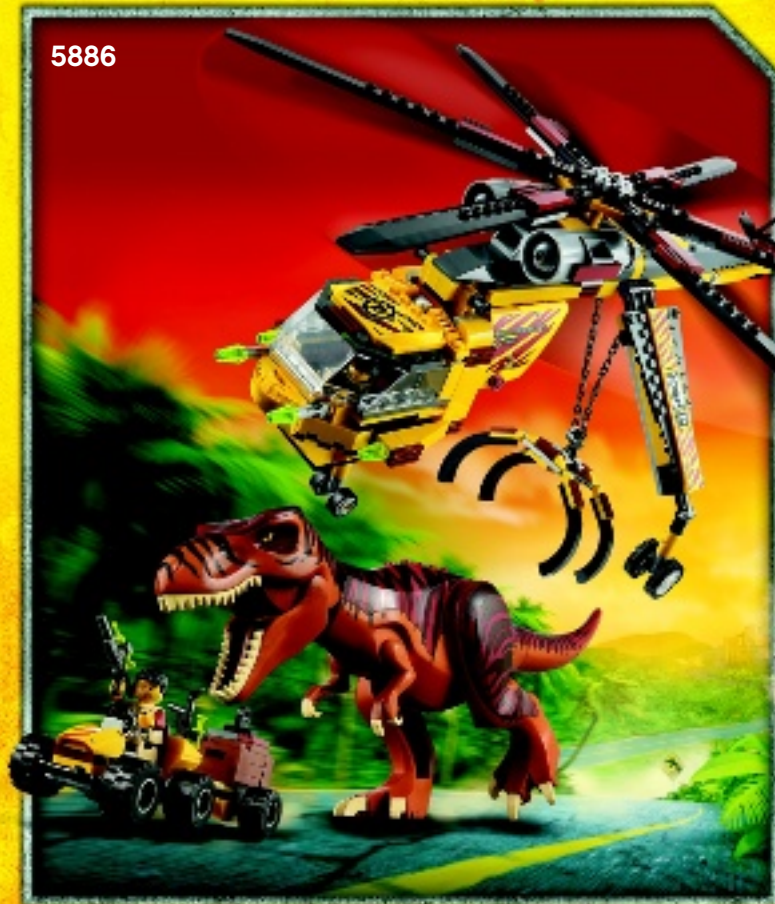

5887



**LEGO club**™

**FREE! GRATIS! GRATUIT!**



**www.LEGOclub.com**



**LEGO® Club Magazine**



**LEGO® Club Email**

**SIGN UP ONLINE!**  
**www.LEGOclub.com**

VISIT THE WORLD'S  
BIGGEST LEGO® SHOP!

**www.LEGOshop.com**



GO TO

**www.LEGOclub.com**

**00800 5346 5555\***



**1-866-534-6258 • 1-877-518-5346**

US & Canada only

Canada seulement



\* Freephone. Mobile charges may apply. \* Numéro sans frais. Des frais peuvent s'appliquer avec les téléphones cellulaires. \* Gebührenfrei, Kosten für Anrufe aus Mobilfunknetzen können abweichen. \* Gratis telefoonnummer vanaf vaste lijn. \* Det er et gratis nummer, når du ringer fra fasttelefon. \* Det är gratis, när du ringer från en fast telefon. \* Numéro sans frais. Des frais peuvent s'appliquer avec les téléphones portables.



# WIN!

Go to [www.LEGOsurvey.com/product](http://www.LEGOsurvey.com/product) to fill out a survey for a chance to win a cool LEGO® Product.

No purchase necessary.

Open to all residents where not prohibited.



[www.LEGO.com](http://www.LEGO.com)



## [www.LEGOsurvey.com/product](http://www.LEGOsurvey.com/product)

### GEWINNE!

Nimm an der Umfrage auf [www.LEGOsurvey.com/product](http://www.LEGOsurvey.com/product) teil und hab die Chance ein cooles LEGO® Produkt zu gewinnen!

Die Teilnahme am Gewinnspiel führt zu keinerlei Kaufverpflichtungen. Teilnahme in allen nicht ausgeschlossenen Ländern möglich.

### WIN!

Ga naar [www.LEGOsurvey.com/product](http://www.LEGOsurvey.com/product), vul een enquêteformulier in en maak kans op een cool LEGO® product.

Geen aankoopverplichting. Iedereen mag deelnemen, uitgezonderd ingezetenden van landen waar een enquêteverbod geldt.

### GAGNE!

Visite [www.LEGOsurvey.com/product](http://www.LEGOsurvey.com/product) pour répondre à un questionnaire et avoir une chance de gagner un produit LEGO® très cool!

Aucune obligation d'achat. Ouvert à tous les résidents des pays autorisés.

### 当てよう!

[www.LEGOsurvey.com/product](http://www.LEGOsurvey.com/product) にアクセスして、アンケートにご記入ください。当選者にはレゴ製品を差し上げます。

お買い上げの必要はありません。禁止されていない限り、すべての皆様にご利用いただけます。